

# KEY MAP

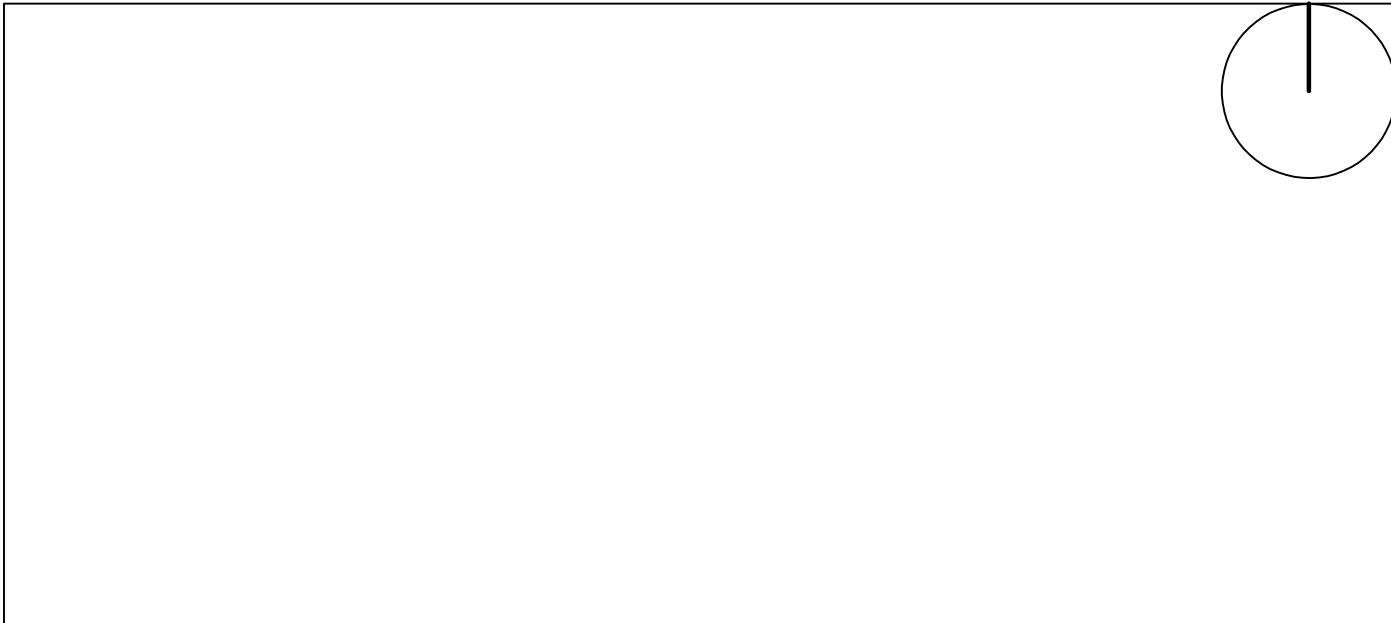

Techbau S.p.A.

Via del Lago, 57  
28053 Castelletto Sopra Ticino (NO) / Italy  
Phone +39 0323 589 500  
info@techbau.it  
[www.techbau.it](http://www.techbau.it)

**Techbau**  
Engineering & Construction

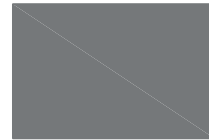

| REV. | DATA | Date | DESCRIZIONE | Description | Drawn by | Appr. by |
|------|------|------|-------------|-------------|----------|----------|
|------|------|------|-------------|-------------|----------|----------|

00 2024/03/20 Descrizione NC NC

PROGETTO Project  
**CITADELLA DELLA LOGISTICA - CRESPINA LORENZANA (PI)**

TITOLO DOCUMENTO Document Title

**UMI 2 - SEZIONI STRADALI**

SCALA Scale  
**1 : 100**

| COMMESSA     | LIVELLO  | ATTIVITA' | PROGRESSIVO | TIPO         | REV. | Il tecnico         |
|--------------|----------|-----------|-------------|--------------|------|--------------------|
| Job          | Level    | Activity  | Number      | Type         | Rev. | Technical designer |
| <b>23P08</b> | <b>D</b> | <b>AR</b> | <b>026</b>  | <b>VW-00</b> |      |                    |

La proprietà di questo disegno è riservata ai termini di legge. Qualunque riproduzione od utilizzazione anche parziale non può essere fatta senza autorizzazione.  
The property of this drawing is reserved according to law. Any reproduction or utilization also partial can't be marked without authorization.

MOD-021

PROFILO lavoriaFE2

SEZIONE 2

PROGRESSIVA 20.00

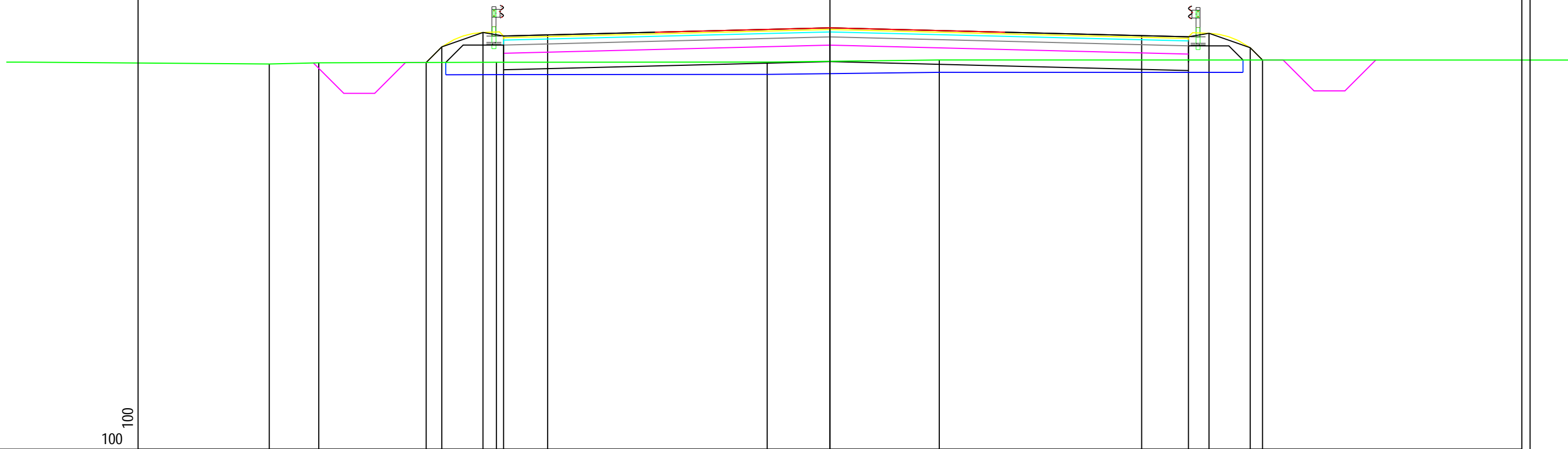

|                      |      |        |        |       |       |       |       |       |      |  |       |      |      |       |       |
|----------------------|------|--------|--------|-------|-------|-------|-------|-------|------|--|-------|------|------|-------|-------|
| PROGRESSIVE TERRENO  |      | -13.61 | -12.41 |       | -8.10 |       | -1.52 |       | 2.65 |  |       |      |      |       |       |
| PARZIALI TERRENO     | 5.97 | 1.20   |        | 4.31  |       | 6.58  |       | 4.17  |      |  | 17.35 |      |      |       |       |
| QUOTE TERRENO        |      | 6.36   | 6.39   |       | 6.40  |       | 6.41  |       | 6.46 |  |       |      |      |       |       |
| PROGRESSIVE PROGETTO |      |        |        | -9.80 | -9.43 | -8.43 | -7.93 | -6.86 | 0.00 |  | 7.57  | 8.70 | 9.20 | 10.20 | 10.50 |
| PARZIALI PROGETTO    |      |        |        | 0.37  | 1.00  | 0.50  | 1.07  |       | 6.86 |  | 7.57  | 1.13 | 0.50 | 1.00  | 0.30  |
| QUOTE PROGETTO       |      |        |        | 6.40  | 6.78  | 7.13  | 7.04  | 7.07  | 7.24 |  | 7.05  | 7.02 | 7.11 | 6.76  | 6.46  |

PROFILO lavoriaFE2

SEZIONE 3

PROGRESSIVA 40.00

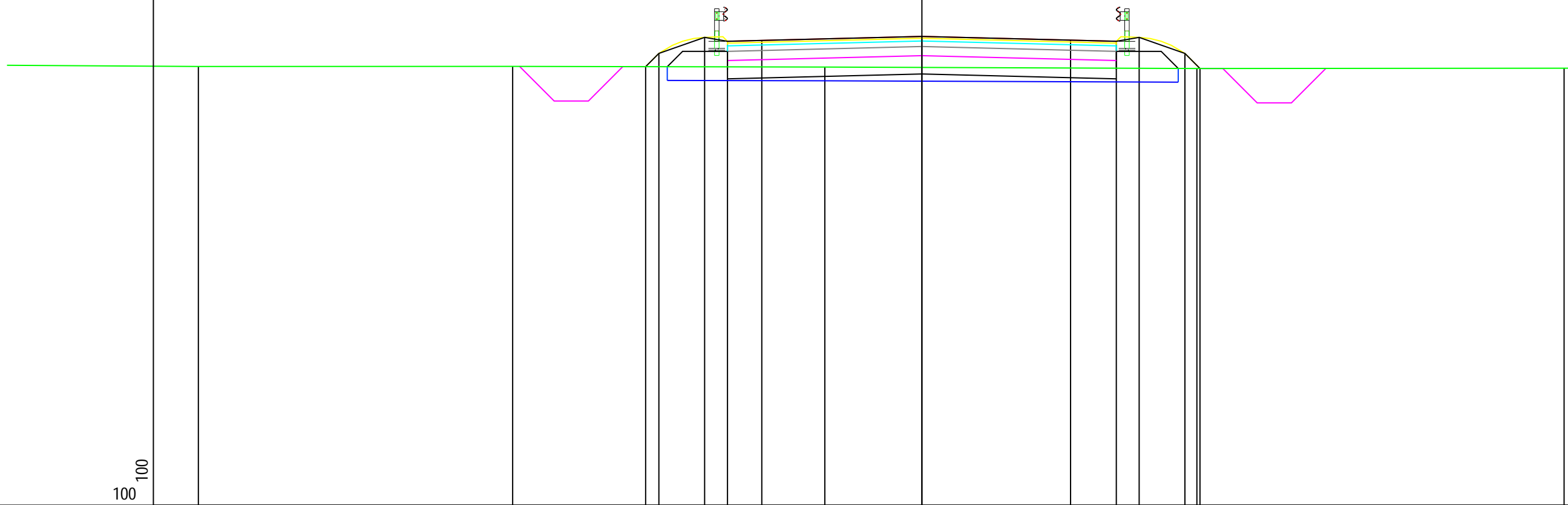

-3

100  
100

|                      |        |       |                |                |       |      |      |              |              |      |              |      |
|----------------------|--------|-------|----------------|----------------|-------|------|------|--------------|--------------|------|--------------|------|
| PROGRESSIVE TERRENO  | -15.82 | -8.95 | -2.12          | 6.01           | 14.04 |      |      |              |              |      |              |      |
| PARZIALI TERRENO     | 4.18   | 6.87  | 6.83           | 8.13           | 8.03  | 3.20 |      |              |              |      |              |      |
| QUOTE TERRENO        | 6.58   | 6.58  | 6.57           | 6.54           | 6.54  |      |      |              |              |      |              |      |
| PROGRESSIVE PROGETTO |        |       | -6.04<br>-5.75 | -4.75<br>-4.25 | -3.50 | 0.00 | 3.25 | 4.25<br>4.75 | 5.75<br>6.08 |      |              |      |
| PARZIALI PROGETTO    |        |       | 0.29           | 1.00           | 0.50  | 0.75 | 3.50 | 3.25         | 1.00         | 0.50 | 1.00         | 0.33 |
| QUOTE PROGETTO       |        |       | 6.58<br>6.87   | 7.22           | 7.13  | 7.15 | 7.24 | 7.16         | 7.13         | 7.22 | 6.87<br>6.54 |      |

PROFILO lavoriaFE2  
 SEZIONE 4  
 PROGRESSIVA 60.00



|                      |        |        |      |       |       |       |       |       |      |       |       |       |       |      |
|----------------------|--------|--------|------|-------|-------|-------|-------|-------|------|-------|-------|-------|-------|------|
| PROGRESSIVE TERRENO  | -16.06 | -12.55 |      | -4.00 |       | 2.19  |       | 8.07  | 8.53 | 10.47 | 11.02 | 13.44 | 16.76 |      |
| PARZIALI TERRENO     | 3.94   | 3.51   | 8.55 |       | 6.19  |       | 5.88  | 0.46  | 1.94 | 0.55  | 2.42  | 3.32  | 3.24  |      |
| QUOTE TERRENO        | 6.63   | 6.62   |      | 6.59  |       | 6.57  |       | 6.52  | 6.45 | 5.96  | 6.07  | 6.52  | 6.60  |      |
| PROGRESSIVE PROGETTO |        |        |      | -6.03 | -5.75 | -4.75 | -4.25 | -3.25 | 0.00 | 3.25  | 4.25  | 4.75  | 5.75  | 6.09 |
| PARZIALI PROGETTO    |        |        |      | 0.28  | 1.00  | 0.50  | 1.00  | 3.25  | 3.25 | 1.00  | 0.50  | 1.00  | 0.34  |      |
| QUOTE PROGETTO       |        |        |      | 6.60  | 6.87  | 7.22  | 7.14  | 7.16  | 7.24 | 7.16  | 7.14  | 7.22  | 6.87  | 6.53 |

PROFILO lavoriaFE2

SEZIONE 5

PROGRESSIVA 80.00

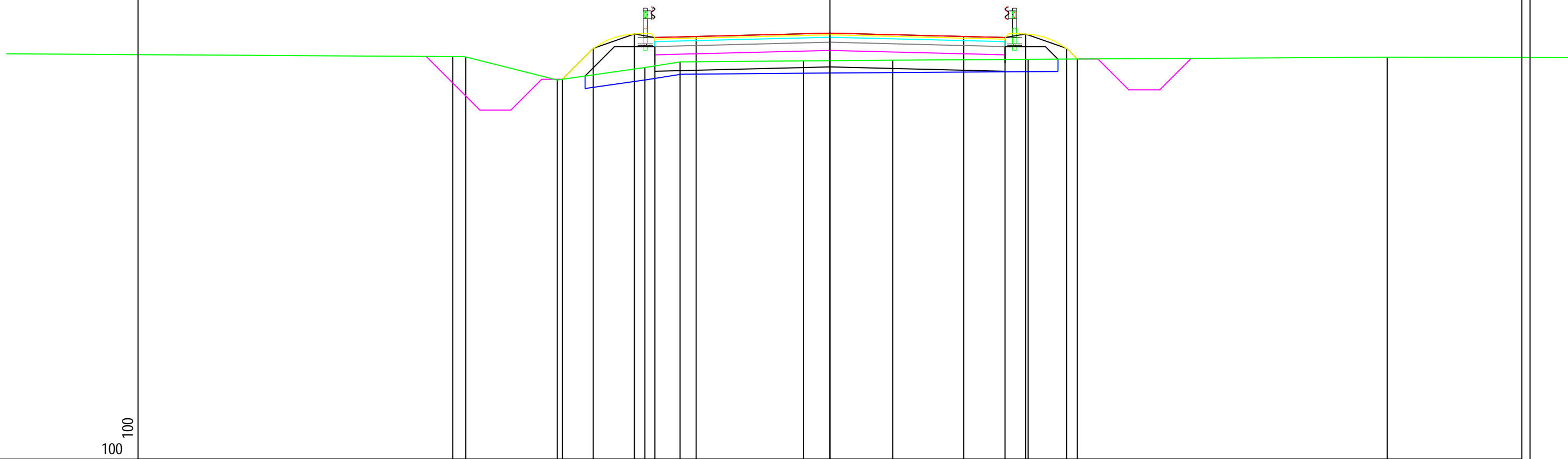

|                      |       |       |       |       |       |       |       |       |      |       |      |      |      |      |
|----------------------|-------|-------|-------|-------|-------|-------|-------|-------|------|-------|------|------|------|------|
| PROGRESSIVE TERRENO  |       | -9.16 | -8.84 | -6.62 | -4.50 | -3.64 | -0.64 | 1.52  | 4.81 | 13.53 |      |      |      |      |
| PARZIALI TERRENO     | 10.84 | 0.32  | 2.22  | 2.12  | 0.86  | 3.00  | 2.16  | 3.29  | 8.72 | 3.56  |      |      |      |      |
| QUOTE TERRENO        |       | 6.78  | 6.77  | 6.21  | 6.51  | 6.65  | 6.67  | 6.69  | 6.71 | 6.76  |      |      |      |      |
| PROGRESSIVE PROGETTO |       |       |       | -6.50 | -5.75 | -4.75 | -4.25 | -3.25 | 0.00 | 3.25  | 4.25 | 4.75 | 5.75 | 6.01 |
| PARZIALI PROGETTO    |       |       |       | 0.75  | 1.00  | 0.50  | 1.00  | 3.25  | 3.25 | 1.00  | 0.50 | 1.00 | 0.26 |      |
| QUOTE PROGETTO       |       |       |       | 6.23  | 6.98  | 7.33  | 7.24  | 7.27  | 7.35 | 7.27  | 7.24 | 7.33 | 6.98 | 6.72 |

PROFILO lavoriaFE2

SEZIONE 6

PROGRESSIVA 100.00

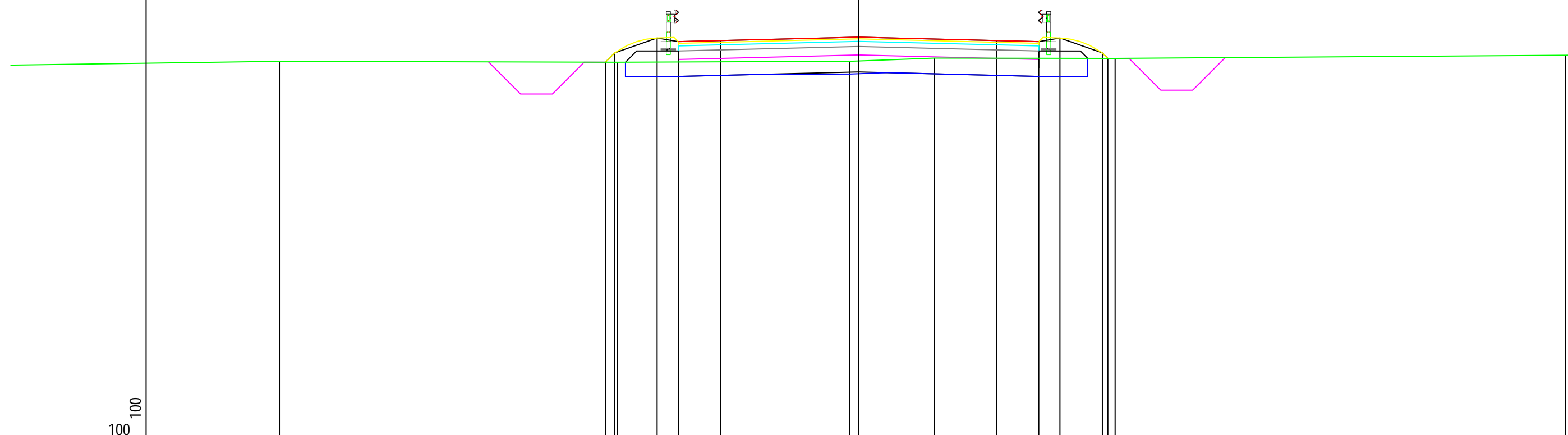

-2

100 100

|                      |      |        |      |                |      |                |      |       |      |      |       |                                      |
|----------------------|------|--------|------|----------------|------|----------------|------|-------|------|------|-------|--------------------------------------|
| PROGRESSIVE TERRENO  |      | -13.66 |      | -5.68          |      | -0.20          |      | 1.79  |      | 6.05 |       | 16.67                                |
| PARZIALI TERRENO     | 6.34 |        | 7.98 |                | 5.48 |                | 1.99 |       | 4.26 |      | 10.62 | 1.43                                 |
| QUOTE TERRENO        |      | 6.93   |      | 6.91           |      | 6.93           |      | 7.00  |      | 7.00 |       | 7.07                                 |
| PROGRESSIVE PROGETTO |      |        |      | -5.97<br>-5.75 |      | -4.75<br>-4.25 |      | -3.25 |      | 0.00 |       | 3.25<br>4.25<br>4.75<br>5.75<br>5.88 |
| PARZIALI PROGETTO    |      |        |      | 0.22           | 1.00 | 0.50           | 1.00 | 3.25  |      | 3.25 |       | 1.00<br>0.50<br>1.00<br>0.13         |
| QUOTE PROGETTO       |      |        |      | 6.91<br>7.13   |      | 7.48<br>7.39   |      | 7.42  |      | 7.50 |       | 7.42<br>7.39<br>7.48<br>7.13<br>7.00 |

PROFILO lavoriaFE2

SEZIONE 7

PROGRESSIVA 120.00

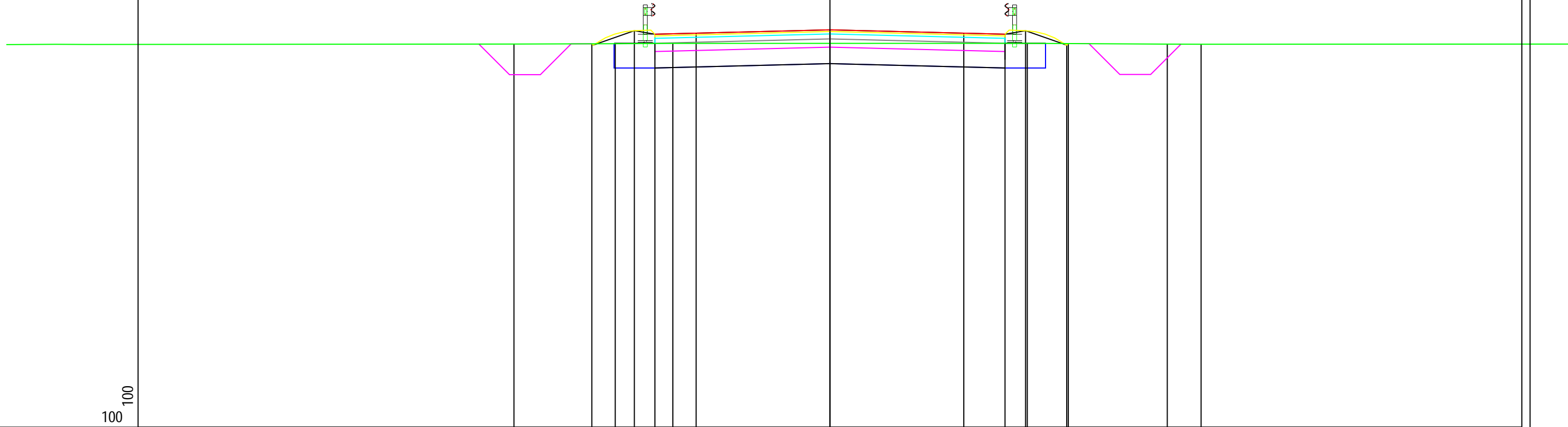

-2

100  
100

|                      |       |  |       |       |       |       |       |      |      |      |      |       |      |      |      |
|----------------------|-------|--|-------|-------|-------|-------|-------|------|------|------|------|-------|------|------|------|
| PROGRESSIVE TERRENO  |       |  | -7.67 | -5.21 | -3.81 |       |       | 4.79 |      | 8.19 | 9.01 |       |      |      |      |
| PARZIALI TERRENO     | 10.38 |  | 2.46  | 1.40  |       |       | 8.60  |      | 3.40 | 0.82 |      | 10.99 |      |      |      |
| QUOTE TERRENO        |       |  | 7.30  | 7.31  | 7.32  |       |       | 7.32 |      | 7.30 | 7.30 |       |      |      |      |
| PROGRESSIVE PROGETTO |       |  |       | -5.78 | -4.75 | -4.25 | -3.25 | 0.00 |      | 3.25 | 4.25 | 4.75  | 5.75 | 5.79 |      |
| PARZIALI PROGETTO    |       |  |       | 1.03  | 0.50  | 1.00  |       | 3.25 |      | 3.25 | 1.00 | 0.50  | 1.00 | 0.04 |      |
| QUOTE PROGETTO       |       |  |       | 7.31  | 7.63  | 7.54  | 7.57  |      | 7.65 |      | 7.57 | 7.54  | 7.63 | 7.28 | 7.31 |







PROFILO lavoriaFE2

SEZIONE 10

PROGRESSIVA 180.00

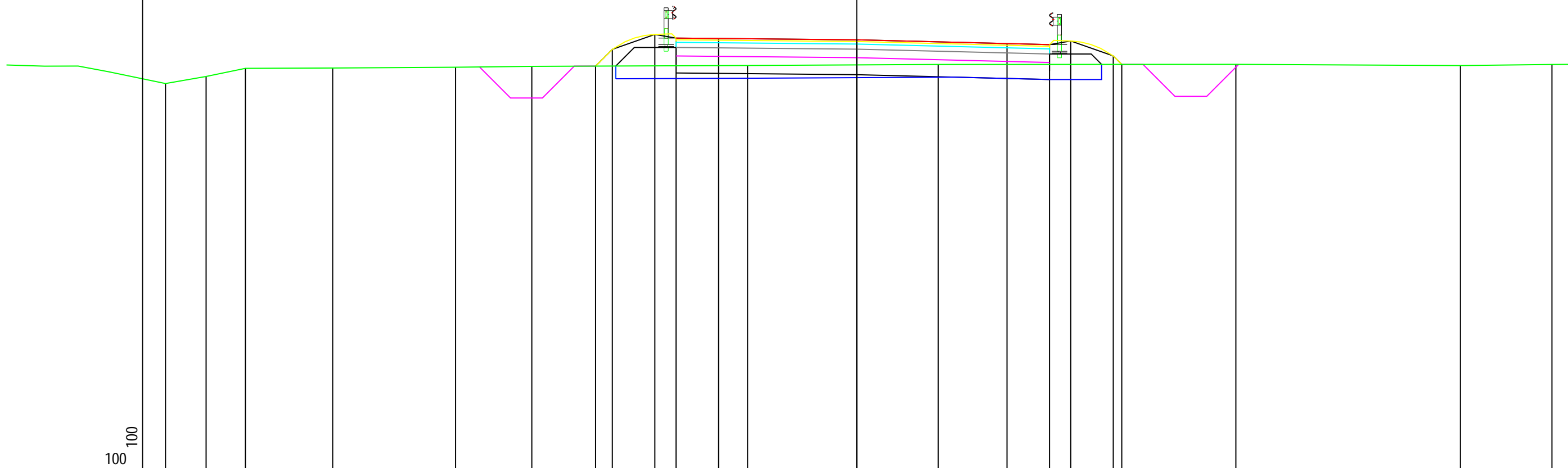

|                      |        |        |        |        |       |       |       |       |       |       |       |      |      |      |      |      |      |
|----------------------|--------|--------|--------|--------|-------|-------|-------|-------|-------|-------|-------|------|------|------|------|------|------|
| PROGRESSIVE TERRENO  | -16.26 | -15.30 | -14.38 | -12.33 | -9.44 | -7.64 | -2.57 | 1.92  | 8.92  | 14.20 | 16.35 |      |      |      |      |      |      |
| PARZIALI TERRENO     | 1.34   | 0.96   | 0.92   | 2.05   | 2.89  | 1.80  | 5.07  | 4.49  | 7.00  | 5.28  | 2.15  | 3.65 |      |      |      |      |      |
| QUOTE TERRENO        | 7.07   | 7.24   | 7.43   | 7.44   | 7.45  | 7.47  | 7.49  | 7.52  | 7.52  | 7.49  | 7.52  |      |      |      |      |      |      |
| PROGRESSIVE PROGETTO |        |        |        |        |       |       | -6.14 | -5.75 | -4.75 | -4.25 | -3.25 | 0.00 | 3.53 | 4.53 | 5.03 | 6.03 | 6.23 |
| PARZIALI PROGETTO    |        |        |        |        |       |       | 0.39  | 1.00  | 0.50  | 1.00  | 3.25  | 3.53 | 1.00 | 0.50 | 1.00 | 0.20 | 0.20 |
| QUOTE PROGETTO       |        |        |        |        |       |       | 7.48  | 7.87  | 8.22  | 8.14  | 8.13  | 8.10 | 8.01 | 7.98 | 8.07 | 7.72 | 7.52 |

PROFILO lavoriaFE2

SEZIONE 11

PROGRESSIVA 200.00

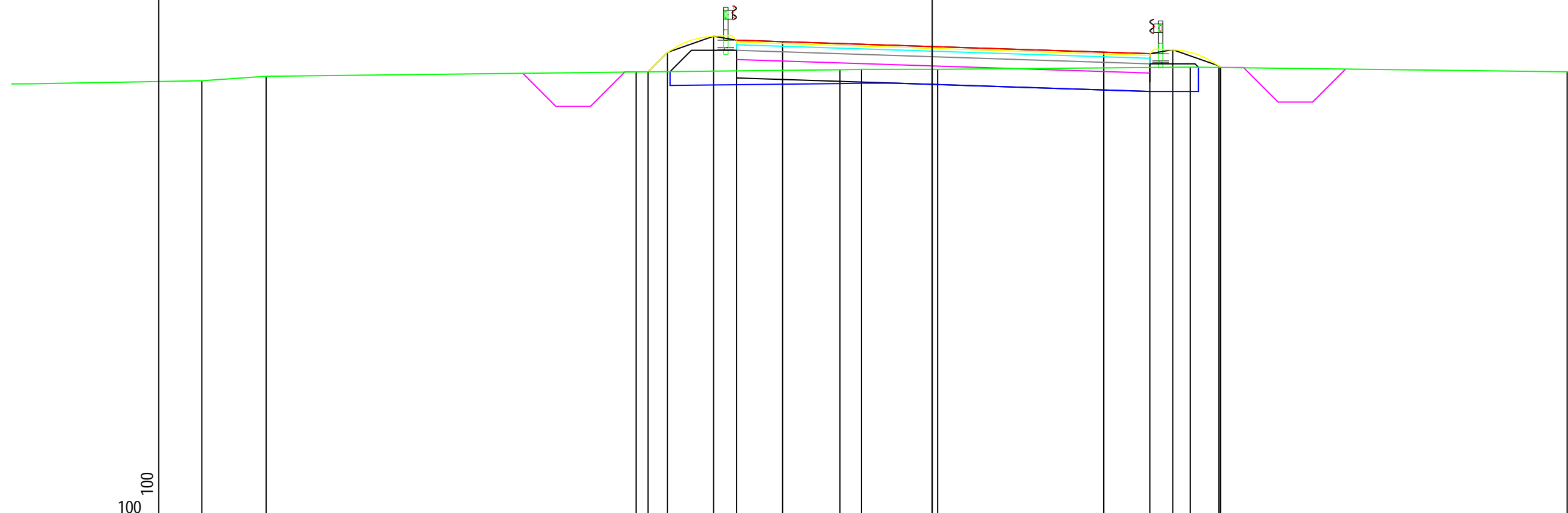

-2

100 100

|                      |        |        |       |       |       |       |       |       |      |      |      |      |      |
|----------------------|--------|--------|-------|-------|-------|-------|-------|-------|------|------|------|------|------|
| PROGRESSIVE TERRENO  | -15.86 | -14.47 | -6.43 | -2.01 | -1.54 | 0.12  | 5.60  | 13.79 |      |      |      |      |      |
| PARZIALI TERRENO     | 3.72   | 1.39   | 8.04  | 4.42  | 0.47  | 1.66  | 5.48  | 8.19  | 4.35 |      |      |      |      |
| QUOTE TERRENO        | 7.51   | 7.60   | 7.70  | 7.74  | 7.75  | 7.75  | 7.80  | 7.70  |      |      |      |      |      |
| PROGRESSIVE PROGETTO |        |        | -6.17 | -5.75 | -4.75 | -4.25 | -3.25 | 0.00  | 3.73 | 4.73 | 5.22 | 6.22 | 6.26 |
| PARZIALI PROGETTO    |        |        | 0.42  | 1.00  | 0.50  | 1.00  | 3.25  | 3.73  | 1.00 | 0.49 | 1.00 | 0.04 |      |
| QUOTE PROGETTO       |        |        | 7.70  | 8.12  | 8.47  | 8.39  | 8.35  | 8.25  | 8.13 | 8.09 | 8.18 | 7.83 | 7.79 |



PROFILO lavoriaFE2

SEZIONE 13

PROGRESSIVA 240.00

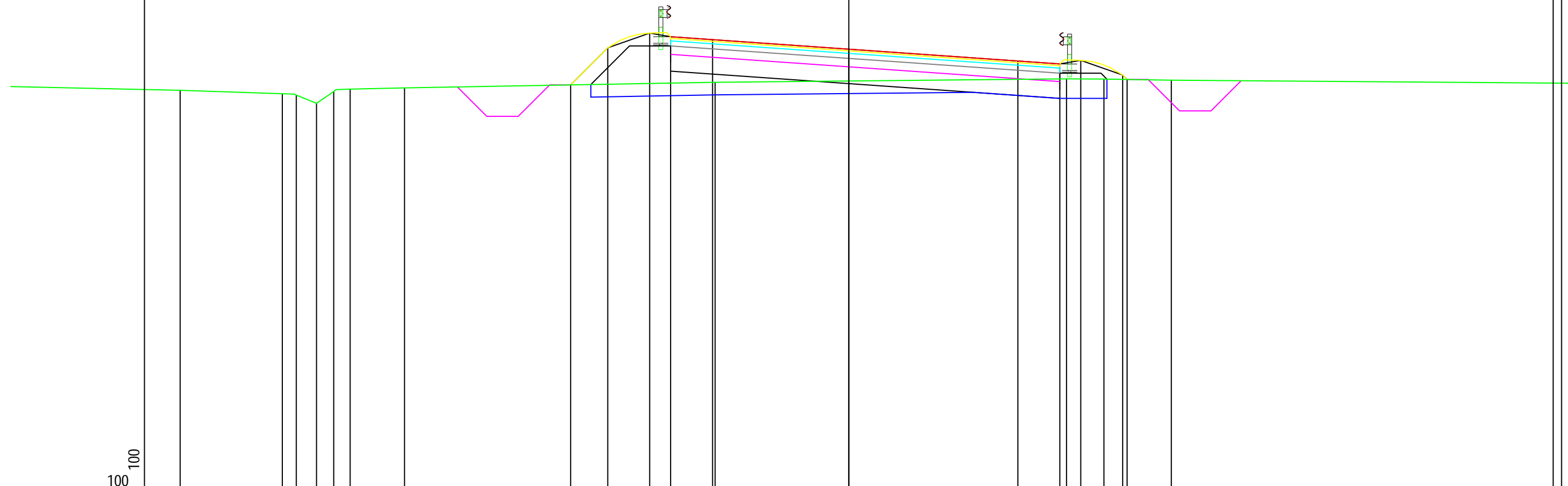

|                      |        |        |        |        |        |        |        |       |      |      |      |       |
|----------------------|--------|--------|--------|--------|--------|--------|--------|-------|------|------|------|-------|
| PROGRESSIVE TERRENO  | -15.95 | -13.51 | -13.18 | -12.70 | -12.29 | -11.89 | -10.60 | -3.19 | 5.19 | 6.09 | 7.69 |       |
| PARZIALI TERRENO     | 4.05   | 2.44   | 0.33   | 0.48   | 0.41   | 0.40   | 1.29   | 7.41  | 8.38 | 0.90 | 1.60 | 10.15 |
| QUOTE TERRENO        | 7.57   | 7.48   | 7.45   | 7.26   | 7.54   | 7.59   | 7.62   | 7.76  | 7.84 | 7.83 | 7.81 |       |
| PROGRESSIVE PROGETTO |        | -6.64  | -5.75  | -4.75  | -4.25  | -3.25  | 0.00   | 4.03  | 5.03 | 5.53 | 6.53 | 6.64  |
| PARZIALI PROGETTO    |        | 0.89   | 1.00   | 0.50   | 1.00   | 3.25   | 4.03   | 1.00  | 0.50 | 1.00 | 0.11 |       |
| QUOTE PROGETTO       |        | 7.70   | 8.58   | 8.93   | 8.85   | 8.78   | 8.55   | 8.27  | 8.20 | 8.28 | 7.93 | 7.83  |

PROFILO lavoriaFE2

SEZIONE 14

PROGRESSIVA 260.00

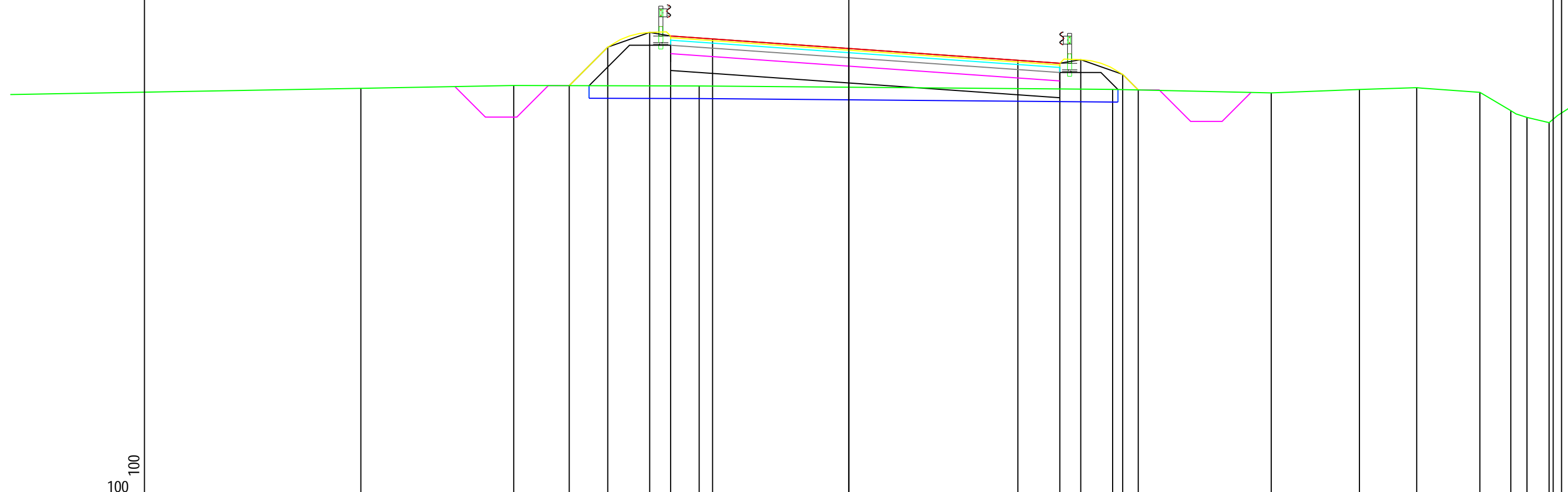

|                      |      |        |       |       |       |       |       |       |       |       |       |       |       |
|----------------------|------|--------|-------|-------|-------|-------|-------|-------|-------|-------|-------|-------|-------|
| PROGRESSIVE TERRENO  |      | -11.64 | -7.99 | -3.57 |       | 6.29  | 10.07 | 12.18 | 13.54 | 15.05 | 15.79 | 16.18 | 16.70 |
| PARZIALI TERRENO     | 8.36 | 3.65   | 4.42  | 9.86  | 3.78  | 2.11  | 1.36  | 1.51  | 0.74  | 0.39  | 0.52  | 0.21  |       |
| QUOTE TERRENO        | 7.75 | 7.82   | 7.80  | 7.72  | 7.64  | 7.72  | 7.76  | 7.65  | 7.22  | 7.05  | 6.93  |       |       |
| PROGRESSIVE PROGETTO |      | -6.67  | -5.75 | -4.75 | -4.25 | -3.25 | 0.00  | 4.03  | 5.03  | 5.53  | 6.53  | 6.90  |       |
| PARZIALI PROGETTO    |      | 0.92   | 1.00  | 0.50  | 1.00  | 3.25  | 4.03  | 1.00  | 0.50  | 1.00  | 0.37  |       |       |
| QUOTE PROGETTO       | 7.81 | 8.73   | 9.08  | 9.00  | 8.93  | 8.70  | 8.42  | 8.35  | 8.43  | 8.08  | 7.71  |       |       |



PROFILO lavoriaFE2

SEZIONE 16

PROGRESSIVA 300.00

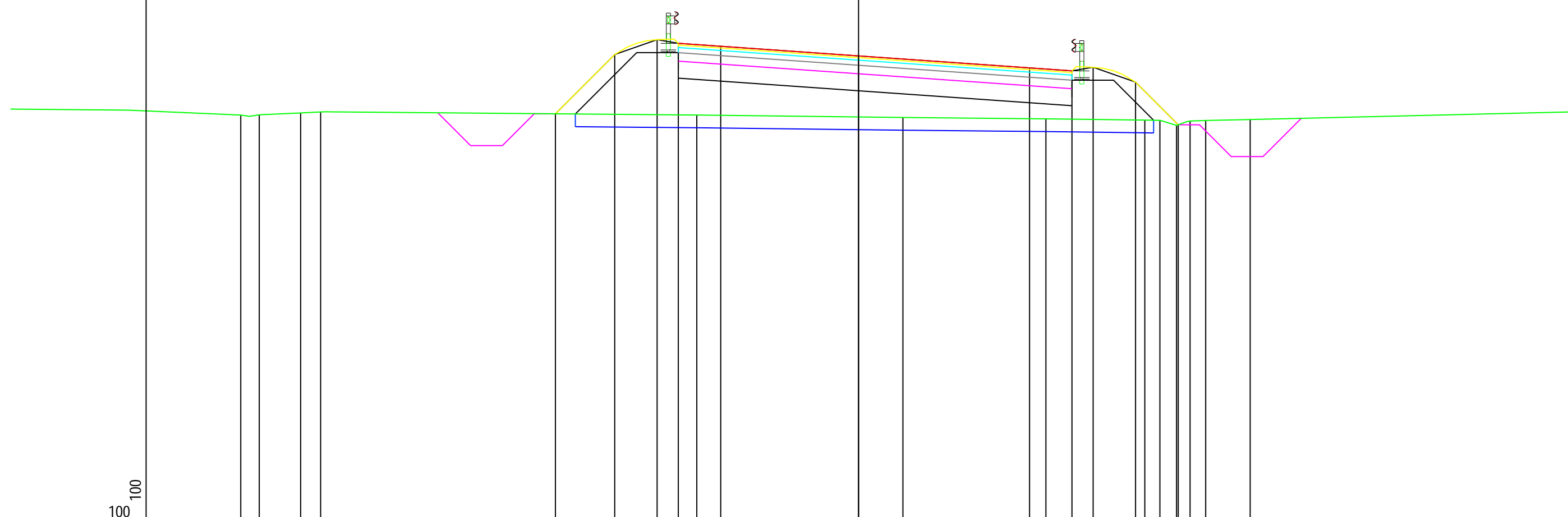

-2

100 100

|                      |      |        |        |        |        |      |       |       |       |       |       |      |      |      |      |      |      |      |      |      |
|----------------------|------|--------|--------|--------|--------|------|-------|-------|-------|-------|-------|------|------|------|------|------|------|------|------|------|
| PROGRESSIVE TERRENO  |      | -14.57 | -14.13 | -13.16 | -12.68 |      | -3.81 |       | 1.05  |       | 4.42  |      | 6.75 | 7.11 | 7.50 | 7.82 | 8.19 |      | 9.24 |      |
| PARZIALI TERRENO     | 2.70 | 0.44   | 0.97   | 0.48   |        | 8.87 |       | 4.86  |       | 3.37  |       | 2.33 | 0.36 | 0.39 | 0.32 | 0.37 |      | 1.05 |      | 7.96 |
| QUOTE TERRENO        |      | 7.60   | 7.61   | 7.65   | 7.68   |      | 7.60  |       | 7.55  |       | 7.51  |      | 7.48 | 7.48 | 7.36 | 7.46 | 7.48 |      | 7.50 |      |
| PROGRESSIVE PROGETTO |      |        |        |        |        |      | -7.15 | -5.75 | -4.75 | -4.25 | -3.25 |      | 0.00 |      | 4.03 | 5.03 | 5.53 |      | 6.53 | 7.54 |
| PARZIALI PROGETTO    |      |        |        |        |        | 1.40 | 1.00  | 0.50  | 1.00  |       | 3.25  |      | 4.03 |      | 1.00 | 0.50 | 1.00 |      | 1.01 |      |
| QUOTE PROGETTO       |      |        |        |        |        | 7.63 | 9.03  | 9.38  | 9.30  | 9.23  |       | 9.00 |      | 8.72 | 8.65 | 8.73 |      | 8.38 |      | 7.37 |



PROFILO lavoriaFE2

SEZIONE 17

PROGRESSIVA 320.00

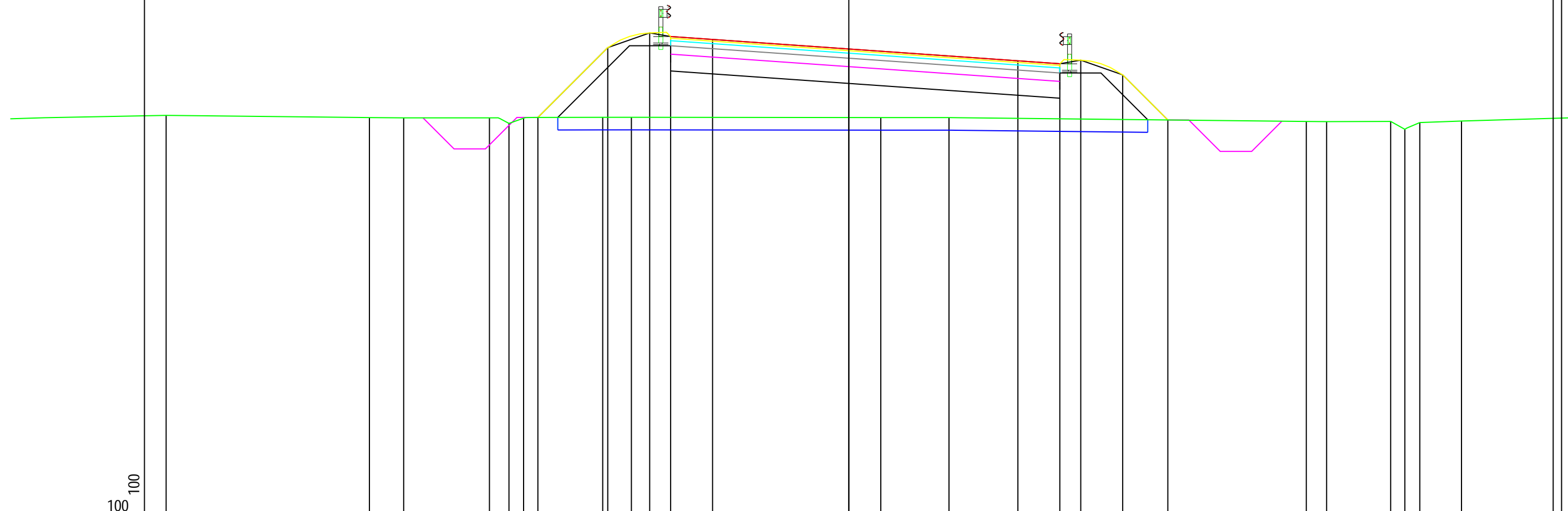

|                      |        |        |        |       |       |       |       |       |      |      |       |       |       |       |       |       |      |
|----------------------|--------|--------|--------|-------|-------|-------|-------|-------|------|------|-------|-------|-------|-------|-------|-------|------|
| PROGRESSIVE TERRENO  | -16.28 | -11.43 | -10.62 | -8.57 | -8.11 | -7.76 | -5.87 | -5.19 | 0.76 | 2.39 | 10.91 | 11.40 | 12.92 | 13.26 | 13.62 | 14.61 |      |
| PARZIALI TERRENO     | 2.90   | 4.85   | 0.81   | 2.05  | 0.46  | 0.35  | 1.89  | 0.68  | 5.95 | 1.63 | 8.52  | 0.49  | 1.52  | 0.34  | 0.36  | 0.99  | 4.31 |
| QUOTE TERRENO        | 7.56   | 7.51   | 7.50   | 7.50  | 7.37  | 7.50  | 7.52  | 7.52  | 7.51 | 7.51 | 7.42  | 7.41  | 7.42  | 7.23  | 7.39  | 7.43  |      |
| PROGRESSIVE PROGETTO |        |        |        | -7.42 | -5.75 | -4.75 | -4.25 | -3.25 | 0.00 | 4.03 | 5.03  | 5.53  | 6.53  | 7.61  |       |       |      |
| PARZIALI PROGETTO    |        |        |        | 1.67  | 1.00  | 0.50  | 1.00  | 3.25  | 4.03 | 1.00 | 0.50  | 1.00  | 1.08  |       |       |       |      |
| QUOTE PROGETTO       |        |        |        | 7.51  | 9.18  | 9.53  | 9.45  | 9.38  | 9.15 | 8.87 | 8.80  | 8.88  | 8.53  | 7.45  |       |       |      |

PROFILO lavoriaFE2

SEZIONE 18

PROGRESSIVA 340.00

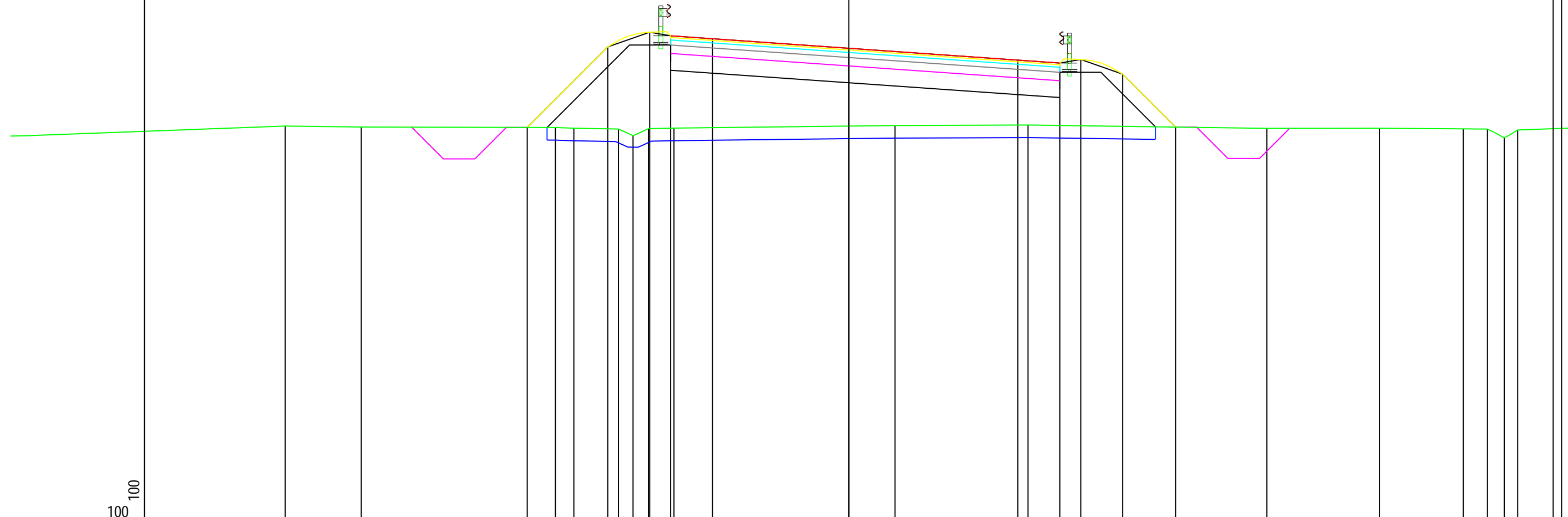

-2

100 100

|                      |      |        |        |  |       |       |       |       |       |       |       |      |      |      |      |      |      |       |      |       |       |       |       |      |
|----------------------|------|--------|--------|--|-------|-------|-------|-------|-------|-------|-------|------|------|------|------|------|------|-------|------|-------|-------|-------|-------|------|
| PROGRESSIVE TERRENO  |      | -13.44 | -11.63 |  | -7.00 | -6.56 | -5.49 | -5.15 | -4.78 | -4.17 |       | 1.10 |      | 4.27 |      | 9.97 |      | 12.66 |      | 14.65 | 15.23 | 15.63 | 15.95 |      |
| PARZIALI TERRENO     | 6.13 |        | 1.81   |  | 4.63  | 0.44  | 1.07  | 0.34  | 0.37  | 0.61  |       | 5.27 |      | 3.17 |      | 5.70 |      | 2.69  |      | 1.99  | 0.58  | 0.40  | 0.32  | 1.70 |
| QUOTE TERRENO        |      | 7.44   | 7.42   |  | 7.41  | 7.39  | 7.37  | 7.22  | 7.38  | 7.39  |       | 7.46 |      | 7.47 |      | 7.39 |      | 7.39  |      | 7.38  | 7.37  | 7.16  | 7.35  |      |
| PROGRESSIVE PROGETTO |      |        |        |  | -7.67 |       | -5.75 |       | -4.75 | -4.25 | -3.25 |      | 0.00 |      | 4.03 | 5.03 | 5.53 | 6.53  | 7.79 |       |       |       |       |      |
| PARZIALI PROGETTO    |      |        |        |  |       | 1.92  |       | 1.00  | 0.50  | 1.00  |       | 3.25 |      | 4.03 |      | 1.00 | 0.50 | 1.00  | 1.26 |       |       |       |       |      |
| QUOTE PROGETTO       |      |        |        |  | 7.41  |       | 9.33  |       | 9.68  | 9.60  | 9.53  |      | 9.30 |      | 9.02 | 8.95 | 9.03 | 8.68  | 7.42 |       |       |       |       |      |

PROFILO lavoriaFE2

SEZIONE 19

PROGRESSIVA 360.00

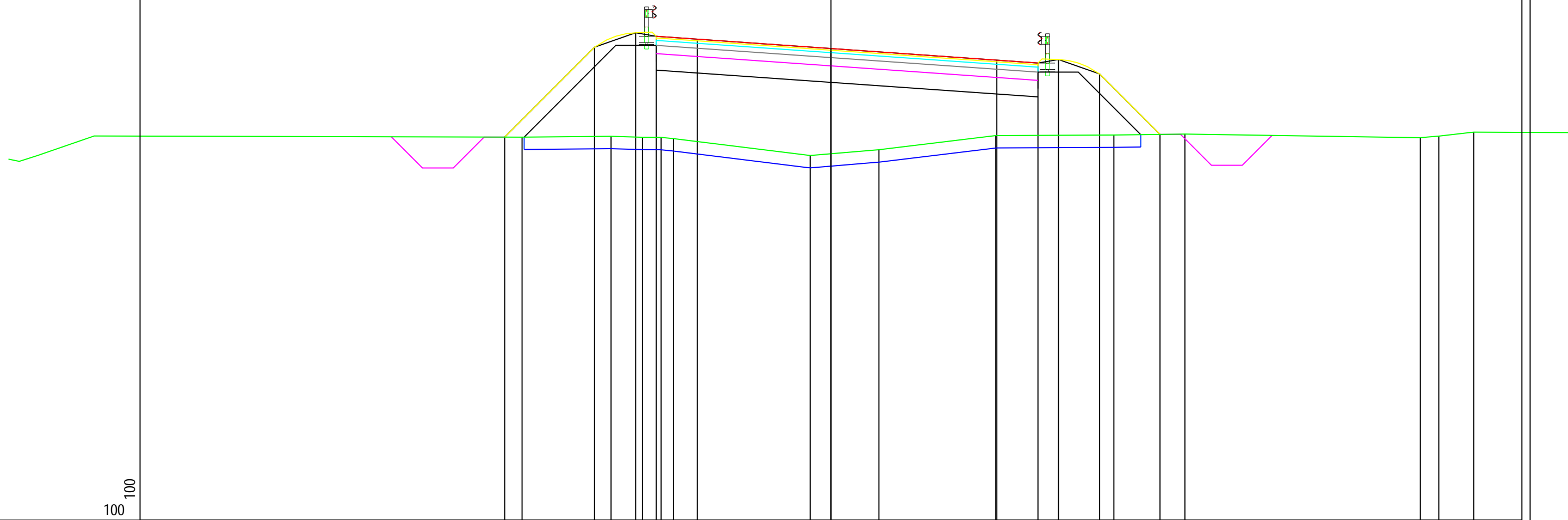

-2

100  
100

|                      |       |  |  |       |      |       |       |       |       |      |       |      |      |      |      |      |      |      |      |  |       |       |       |      |
|----------------------|-------|--|--|-------|------|-------|-------|-------|-------|------|-------|------|------|------|------|------|------|------|------|--|-------|-------|-------|------|
| PROGRESSIVE TERRENO  |       |  |  | -7.51 |      | -5.35 | -4.58 | -4.13 | -3.83 |      | -0.51 | 1.17 |      | 4.01 |      | 6.88 | 8.61 |      |      |  | 14.33 | 14.78 | 15.63 |      |
| PARZIALI TERRENO     | 10.41 |  |  | 2.16  | 0.77 | 0.45  | 0.30  |       | 3.32  |      | 1.68  |      | 2.84 |      | 2.87 |      | 1.73 |      | 5.72 |  |       | 0.45  | 0.85  | 3.52 |
| QUOTE TERRENO        |       |  |  | 7.30  | 7.32 | 7.30  | 7.30  | 7.27  |       | 6.86 | 7.00  |      | 7.34 |      | 7.35 |      | 7.38 |      |      |  | 7.29  | 7.33  | 7.43  |      |
| PROGRESSIVE PROGETTO |       |  |  | -7.93 |      | -5.75 | -4.75 | -4.25 | -3.25 |      | 0.00  |      |      |      | 4.03 | 5.03 | 5.53 | 6.53 | 8.00 |  |       |       |       |      |
| PARZIALI PROGETTO    |       |  |  | 2.18  | 1.00 | 0.50  | 1.00  |       | 3.25  |      |       | 4.03 |      | 1.00 | 0.50 | 1.00 | 1.47 |      |      |  |       |       |       |      |
| QUOTE PROGETTO       |       |  |  | 7.30  | 9.49 | 9.84  | 9.75  | 9.68  |       | 9.46 |       |      | 9.17 | 9.10 | 9.19 | 8.84 | 7.37 |      |      |  |       |       |       |      |

PROFILO lavoriaFE2  
 SEZIONE 20  
 PROGRESSIVA 380.00

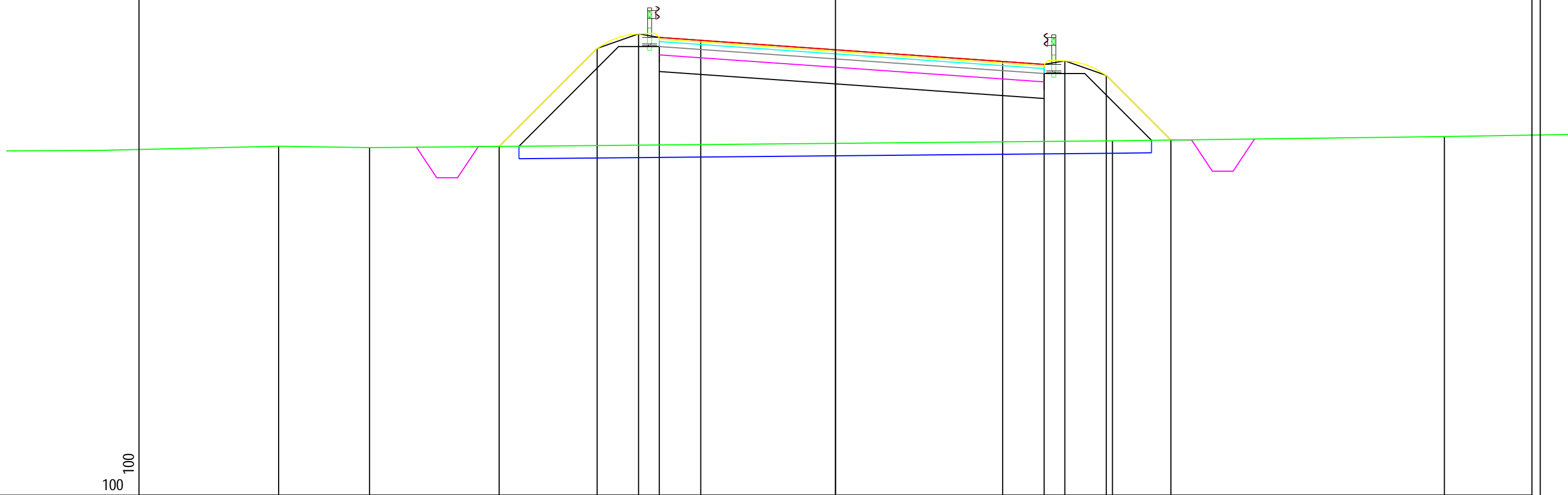

|                      |      |        |        |       |       |       |       |       |       |      |      |      |      |      |      |       |
|----------------------|------|--------|--------|-------|-------|-------|-------|-------|-------|------|------|------|------|------|------|-------|
| PROGRESSIVE TERRENO  |      | -13.43 | -11.24 |       |       |       |       |       |       |      |      | 6.68 |      |      |      | 14.69 |
| PARZIALI TERRENO     | 4.26 |        | 2.19   |       |       |       |       |       | 17.92 |      |      |      |      |      | 8.01 | 3.05  |
| QUOTE TERRENO        |      | 7.41   | 7.38   |       |       |       |       |       |       |      |      | 7.54 |      |      |      | 7.64  |
| PROGRESSIVE PROGETTO |      |        |        | -8.11 | -5.75 | -4.75 | -4.25 | -3.25 |       | 0.00 |      | 4.03 | 5.03 | 5.53 | 6.53 | 8.09  |
| PARZIALI PROGETTO    |      |        |        | 2.36  | 1.00  | 0.50  | 1.00  |       | 3.25  |      | 4.03 | 1.00 | 0.50 | 1.00 | 1.56 |       |
| QUOTE PROGETTO       |      | 7.40   |        | 9.77  | 10.12 | 10.03 |       | 9.96  |       | 9.73 |      | 9.45 | 9.38 | 9.47 | 9.12 | 7.56  |

PROFILO lavoriaFE2

SEZIONE 21

PROGRESSIVA 400.00

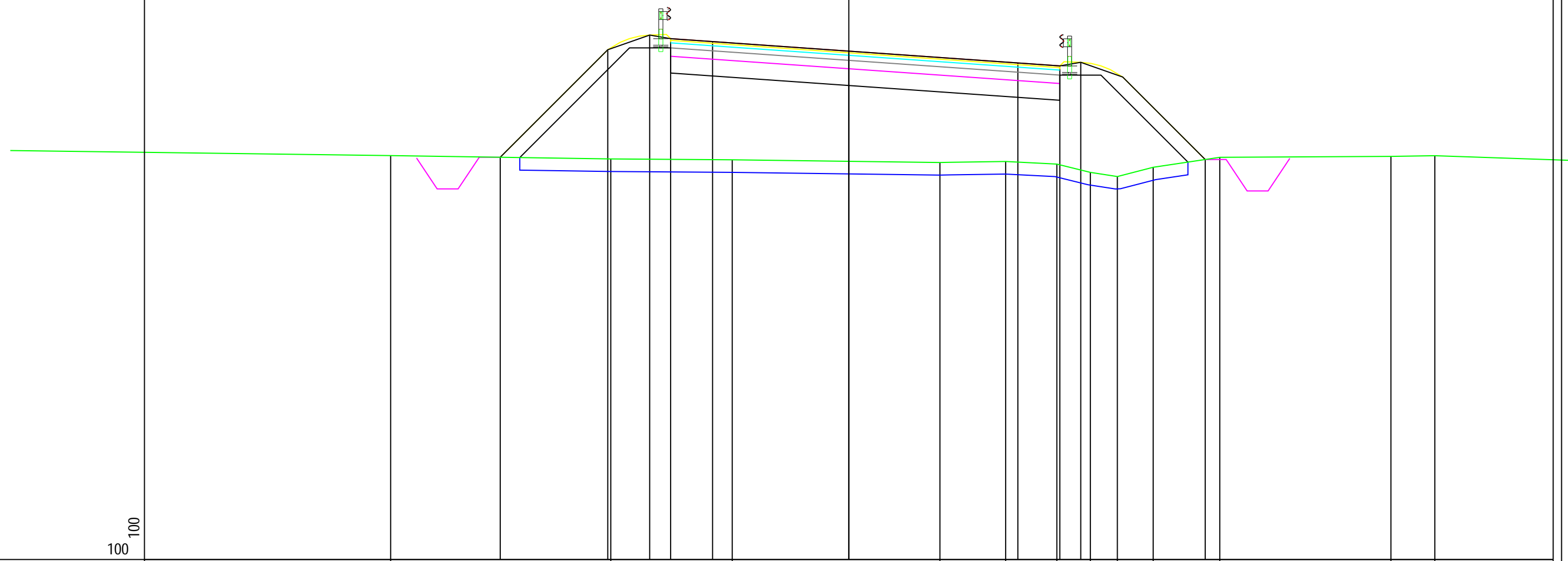

-2

100  
100

|                      |      |        |       |       |       |       |       |       |      |      |      |      |      |      |  |       |       |      |
|----------------------|------|--------|-------|-------|-------|-------|-------|-------|------|------|------|------|------|------|--|-------|-------|------|
| PROGRESSIVE TERRENO  |      | -10.93 |       | -5.68 |       | -2.78 |       | 2.17  | 3.74 | 4.96 | 5.76 | 6.40 | 7.26 | 8.85 |  | 12.93 | 13.98 |      |
| PARZIALI TERRENO     | 9.07 |        | 5.25  |       | 2.90  |       | 4.95  |       | 1.57 | 1.22 | 0.80 | 0.64 | 0.86 | 1.59 |  | 4.08  | 1.05  | 5.45 |
| QUOTE TERRENO        |      | 7.64   |       | 7.56  |       | 7.54  |       | 7.47  | 7.50 | 7.43 | 7.24 | 7.14 | 7.36 | 7.60 |  | 7.62  | 7.63  |      |
| PROGRESSIVE PROGETTO |      |        | -8.31 | -5.75 | -4.75 | -4.25 | -3.25 | 0.00  |      | 4.03 | 5.03 | 5.53 | 6.53 | 8.50 |  |       |       |      |
| PARZIALI PROGETTO    |      |        |       | 2.56  | 1.00  | 0.50  | 1.00  | 3.25  |      | 4.03 | 1.00 | 0.50 | 1.00 | 1.97 |  |       |       |      |
| QUOTE PROGETTO       |      |        | 7.60  | 10.16 | 10.51 | 10.43 | 10.36 | 10.13 |      | 9.85 | 9.78 | 9.86 | 9.51 | 7.54 |  |       |       |      |

PROFILO lavoriaFE2

SEZIONE 22

PROGRESSIVA 420.00

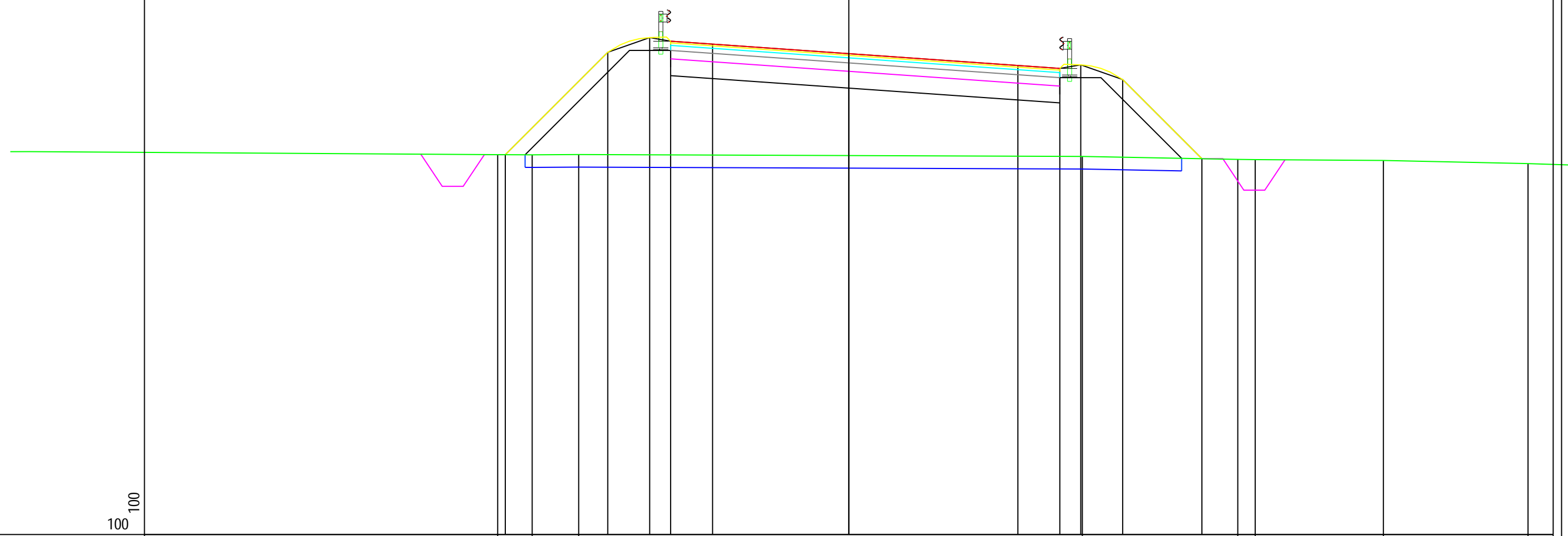

-1

100  
100

|                      |       |       |       |       |       |       |       |      |       |      |       |       |       |      |       |
|----------------------|-------|-------|-------|-------|-------|-------|-------|------|-------|------|-------|-------|-------|------|-------|
| PROGRESSIVE TERRENO  |       | -8.37 | -7.55 | -6.44 |       |       |       | 5.57 |       | 9.28 | 9.69  |       | 12.75 |      | 16.20 |
| PARZIALI TERRENO     | 11.18 | 0.82  | 1.11  |       |       | 12.01 |       | 3.71 | 0.41  | 3.06 |       | 3.45  | 2.25  |      |       |
| QUOTE TERRENO        |       | 8.06  | 8.06  | 8.07  |       |       |       | 8.02 |       | 7.95 | 7.94  |       | 7.92  |      | 7.85  |
| PROGRESSIVE PROGETTO |       | -8.19 |       | -5.75 | -4.75 | -4.25 | -3.25 |      | 0.00  |      | 4.03  | 5.03  | 5.53  | 6.53 | 8.42  |
| PARZIALI PROGETTO    |       |       | 2.44  | 1.00  | 0.50  | 1.00  | 3.25  |      | 4.03  | 1.00 | 0.50  | 1.00  | 1.89  |      |       |
| QUOTE PROGETTO       |       | 8.06  |       | 10.51 | 10.86 | 10.71 | 10.70 |      | 10.47 |      | 10.19 | 10.12 | 10.21 | 9.86 | 7.97  |

PROFILO lavoriaFE2  
 SEZIONE 23  
 PROGRESSIVA 437.88

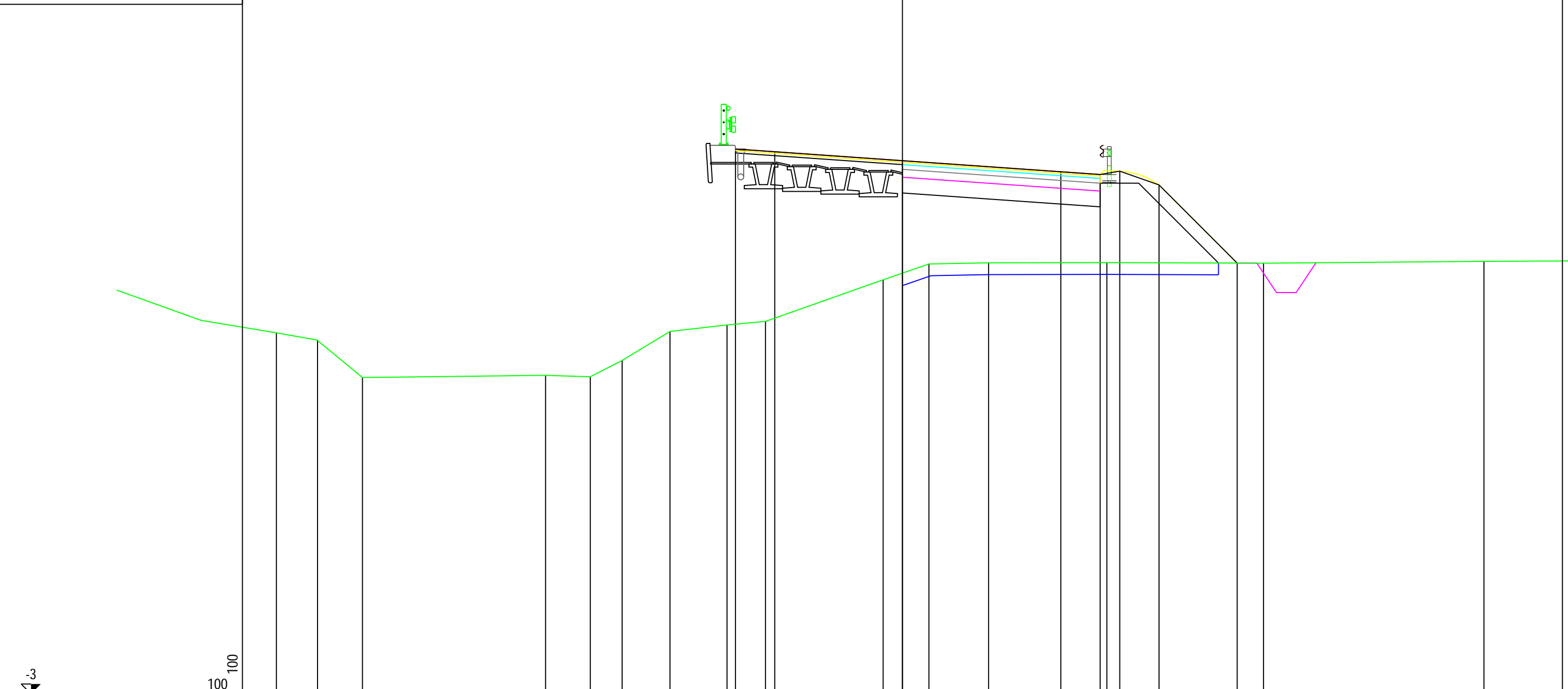

|                      |        |        |        |      |  |  |       |       |       |       |       |       |       |       |      |       |       |       |      |      |      |      |      |       |
|----------------------|--------|--------|--------|------|--|--|-------|-------|-------|-------|-------|-------|-------|-------|------|-------|-------|-------|------|------|------|------|------|-------|
| PROGRESSIVE TERRENO  | -15.94 | -14.89 | -13.74 |      |  |  | -9.08 | -7.95 | -7.13 | -5.92 | -4.47 | -3.49 | -0.49 | 0.67  | 2.19 |       |       | 5.20  |      |      | 9.19 |      |      | 14.80 |
| PARZIALI TERRENO     | 1.91   | 1.05   | 1.15   | 4.66 |  |  | 1.13  | 0.82  | 1.21  | 1.45  | 0.98  | 3.00  | 1.16  | 1.52  | 3.01 |       |       | 3.99  |      |      | 5.61 |      |      | 5.20  |
| QUOTE TERRENO        | 6.19   | 6.00   | 5.05   |      |  |  | 5.11  | 5.07  | 5.49  | 6.22  | 6.39  | 6.48  | 7.54  | 7.94  | 7.97 |       |       | 7.98  |      |      | 7.96 |      |      | 8.01  |
| PROGRESSIVE PROGETTO |        |        |        |      |  |  |       |       |       |       | -4.25 | -3.25 |       | 0.00  |      |       | 4.03  | 5.03  | 5.53 | 6.53 |      |      | 8.52 |       |
| PARZIALI PROGETTO    |        |        |        |      |  |  |       |       |       |       | 1.00  | 3.25  |       | 4.03  |      | 1.00  | 0.50  | 1.00  | 1.99 |      |      |      |      |       |
| QUOTE PROGETTO       |        |        |        |      |  |  |       |       |       |       | 10.87 | 10.80 |       | 10.57 |      | 10.29 | 10.22 | 10.30 | 9.95 |      |      | 7.96 |      |       |

PROFILO lavoriaFE2

SEZIONE 24

PROGRESSIVA 443.88

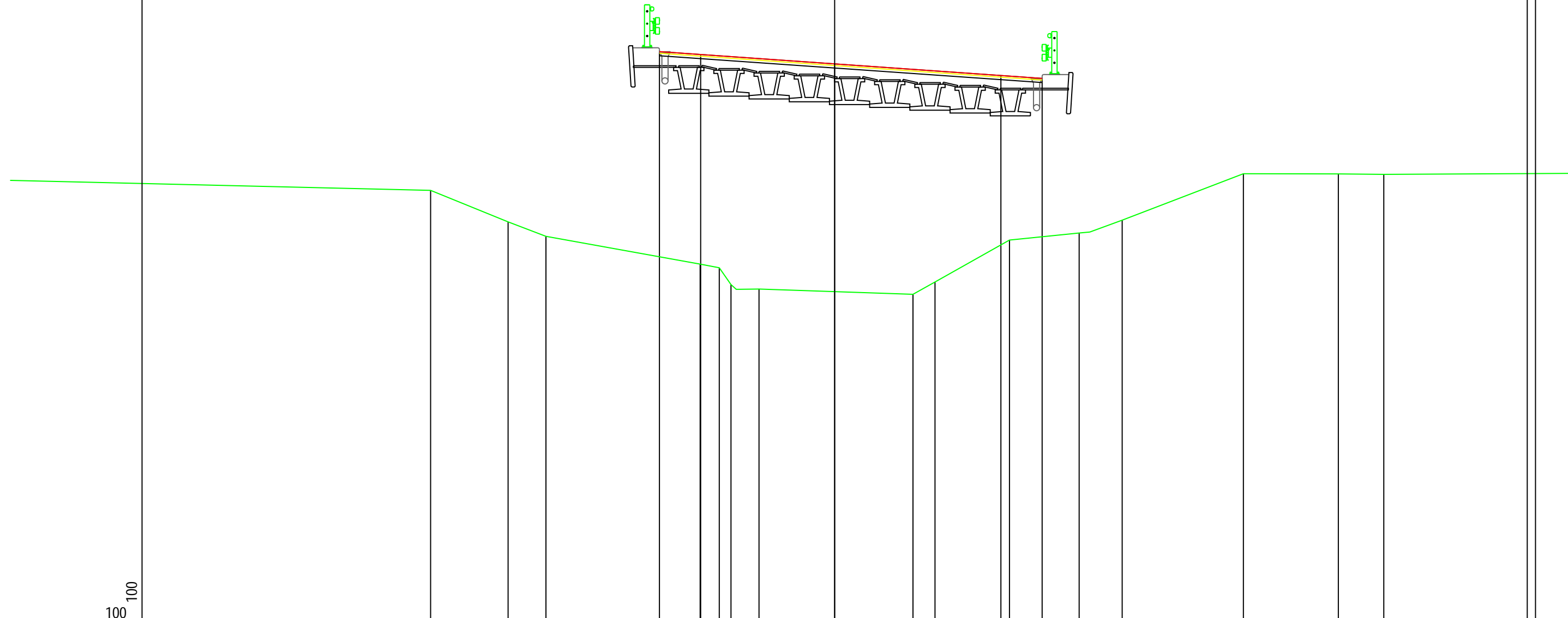

|                      |       |       |       |       |       |       |       |       |       |      |       |       |      |      |      |      |       |       |
|----------------------|-------|-------|-------|-------|-------|-------|-------|-------|-------|------|-------|-------|------|------|------|------|-------|-------|
| PROGRESSIVE TERRENO  |       | -9.80 | -7.92 | -7.00 |       | -3.26 | -2.80 | -2.51 | -1.83 |      | 1.90  | 2.43  | 4.24 | 5.93 | 6.97 | 9.91 | 12.22 | 13.32 |
| PARZIALI TERRENO     | 10.20 | 1.88  | 0.92  | 3.74  | 0.46  | 0.29  | 0.68  | 3.73  | 0.53  | 1.81 | 1.69  | 1.04  | 2.94 | 2.31 | 1.10 | 6.68 |       |       |
| QUOTE TERRENO        |       | 7.50  | 6.74  | 6.39  | 5.71  | 5.62  | 5.21  | 5.11  | 4.98  | 5.28 | 6.29  | 6.47  | 6.78 | 7.90 | 7.90 | 7.89 |       |       |
| PROGRESSIVE PROGETTO |       |       |       |       | -4.25 | -3.25 |       | 0.00  |       |      | 4.03  | 5.03  |      |      |      |      |       |       |
| PARZIALI PROGETTO    |       |       |       |       | 1.00  | 3.25  |       | 4.03  |       | 1.00 |       |       |      |      |      |      |       |       |
| QUOTE PROGETTO       |       |       |       |       | 10.87 | 10.80 |       | 10.57 |       |      | 10.29 | 10.22 |      |      |      |      |       |       |





PROFILO lavoriaFE2  
 SEZIONE 26  
 PROGRESSIVA 460.00

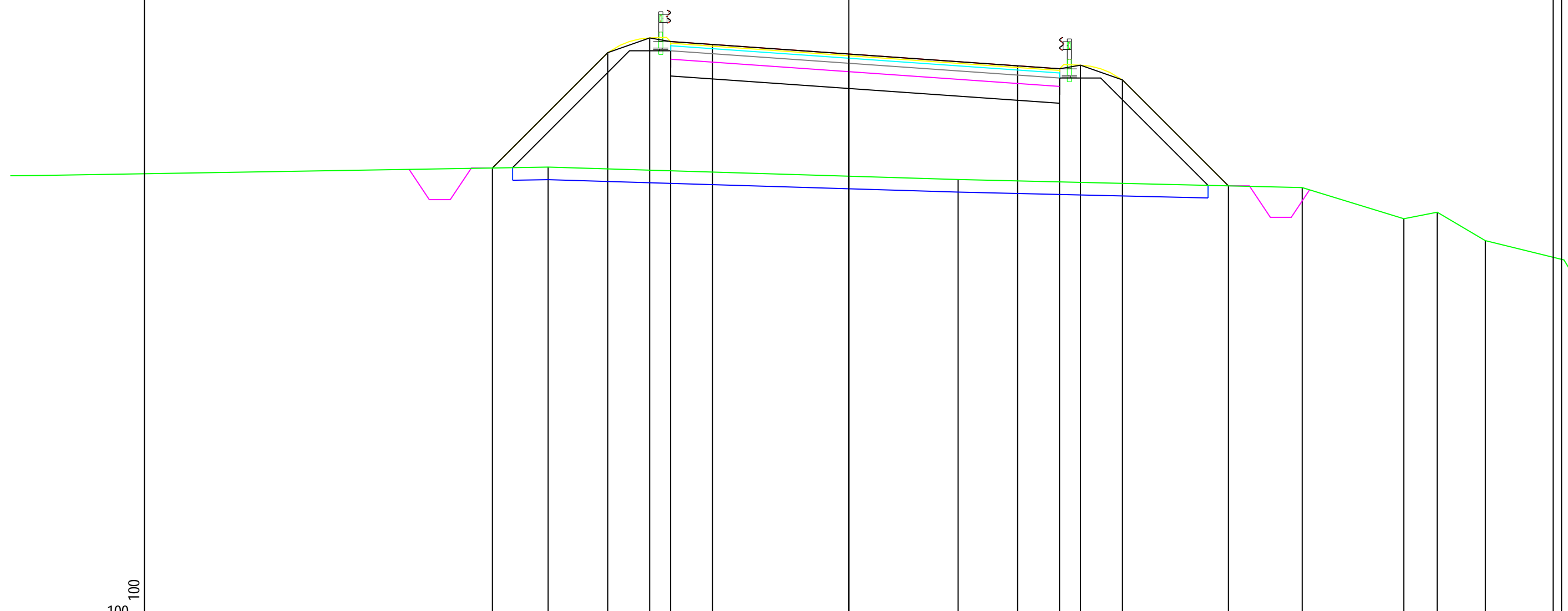

-3  
 100  
 100

|                      |       |       |       |       |       |       |       |       |       |       |      |      |
|----------------------|-------|-------|-------|-------|-------|-------|-------|-------|-------|-------|------|------|
| PROGRESSIVE TERRENO  |       | -7.17 |       | 2.61  |       | 10.81 | 13.24 | 14.03 | 15.18 |       |      |      |
| PARZIALI TERRENO     | 12.12 |       | 9.78  |       | 8.20  | 2.43  | 0.79  | 1.15  | 1.88  |       |      |      |
| QUOTE TERRENO        |       | 7.84  |       | 7.55  |       | 7.36  | 6.61  | 6.77  | 6.09  |       |      |      |
| PROGRESSIVE PROGETTO |       | -8.50 | -5.75 | -4.75 | -4.25 | -3.25 | 0.00  | 4.03  | 5.03  | 5.53  | 6.53 | 9.05 |
| PARZIALI PROGETTO    |       | 2.75  | 1.00  | 0.50  | 1.00  | 3.25  | 4.03  | 1.00  | 0.50  | 1.00  | 2.52 |      |
| QUOTE PROGETTO       |       | 7.82  | 10.57 | 10.92 | 10.84 | 10.77 | 10.54 | 10.26 | 10.19 | 10.27 | 9.92 | 7.40 |

PROFILO lavoriaFE2

SEZIONE 27

PROGRESSIVA 480.00

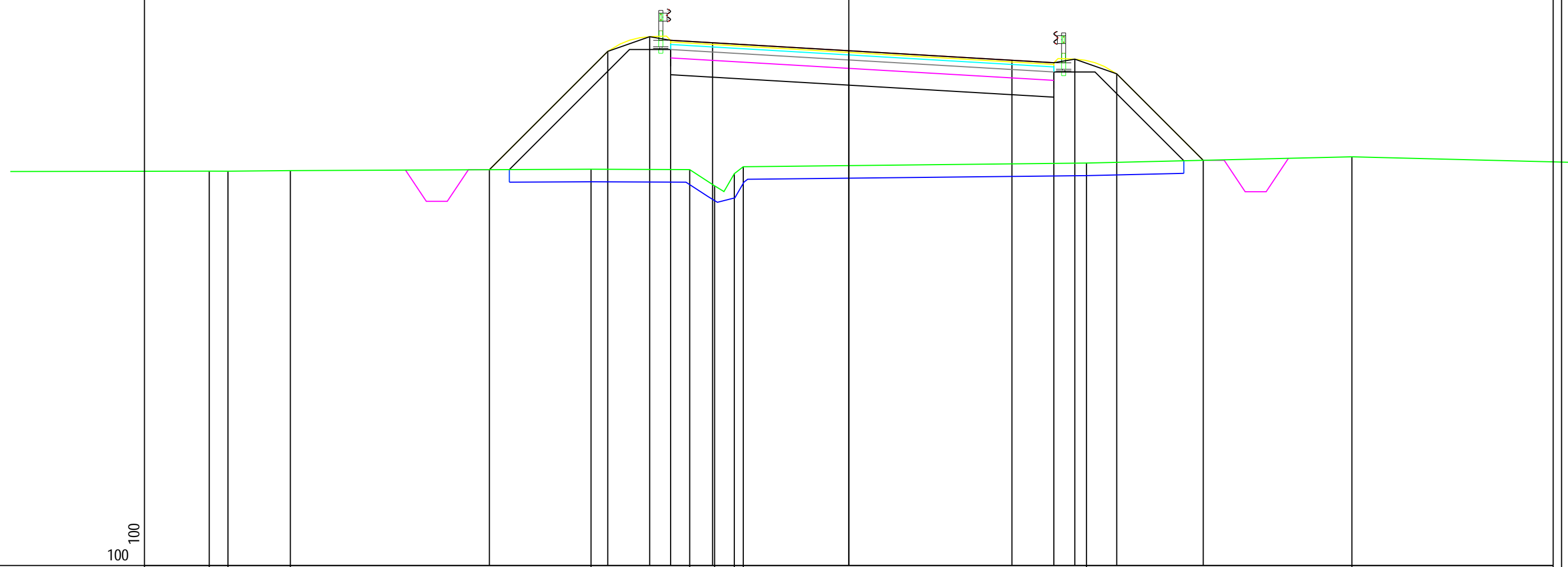

-2  
100 100

|                      |      |        |        |        |       |       |       |       |       |       |       |      |       |       |       |      |       |      |      |
|----------------------|------|--------|--------|--------|-------|-------|-------|-------|-------|-------|-------|------|-------|-------|-------|------|-------|------|------|
| PROGRESSIVE TERRENO  |      | -15.25 | -14.81 | -13.32 |       | -6.15 |       | -3.80 | -3.20 | -2.73 | -2.52 |      |       | 5.67  |       |      | 12.00 |      |      |
| PARZIALI TERRENO     | 4.75 | 0.44   | 1.49   |        | 7.17  |       | 2.35  | 0.60  | 0.47  | 0.21  |       |      | 8.19  |       |       | 6.33 | 5.24  |      |      |
| QUOTE TERRENO        | 7.41 | 7.41   | 7.42   |        | 7.46  |       | 7.45  | 7.06  | 7.35  | 7.52  |       |      | 7.60  |       |       | 7.75 |       |      |      |
| PROGRESSIVE PROGETTO |      |        |        |        | -8.57 |       | -5.75 | -4.75 | -4.25 | -3.25 |       |      | 0.00  |       | 3.89  | 4.89 | 5.39  | 6.39 | 8.45 |
| PARZIALI PROGETTO    |      |        | 2.82   |        | 1.00  | 0.50  | 1.00  |       | 3.25  |       |       | 3.89 | 1.00  | 0.50  | 1.00  | 2.06 |       |      |      |
| QUOTE PROGETTO       |      |        | 7.44   |        | 10.27 | 10.62 | 10.53 | 10.47 |       | 10.28 |       |      | 10.06 | 10.00 | 10.08 | 9.73 | 7.67  |      |      |

PROFILO lavoriaFE2

SEZIONE 28

PROGRESSIVA 500.00

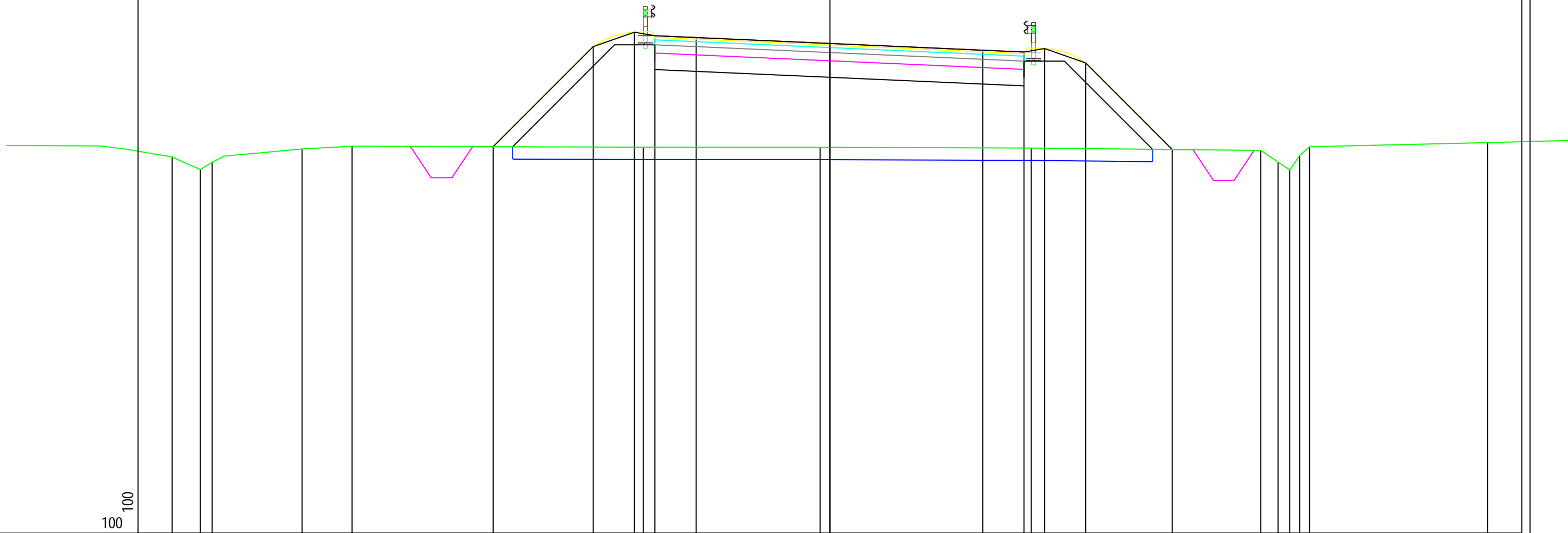

-2

100 100

|                      |      |        |        |        |      |        |        |       |       |       |       |      |      |      |       |       |       |       |       |      |       |
|----------------------|------|--------|--------|--------|------|--------|--------|-------|-------|-------|-------|------|------|------|-------|-------|-------|-------|-------|------|-------|
| PROGRESSIVE TERRENO  |      | -15.97 | -15.29 | -15.00 |      | -12.82 | -11.60 |       | -4.53 |       | -0.24 |      | 4.89 |      | 10.46 | 10.88 | 11.16 | 11.40 | 11.65 |      | 15.97 |
| PARZIALI TERRENO     | 1.14 | 0.68   | 0.29   | 2.18   | 1.22 |        | 7.07   |       | 4.29  |       | 5.13  |      | 5.57 |      | 0.42  | 0.28  | 0.24  | 0.25  |       | 4.32 | 4.03  |
| QUOTE TERRENO        | 7.13 | 6.83   | 7.00   |        | 7.32 | 7.39   |        | 7.37  |       | 7.36  |       | 7.35 |      | 7.29 | 7.00  | 6.81  | 7.16  | 7.38  |       | 7.48 |       |
| PROGRESSIVE PROGETTO |      |        |        |        |      | -8.18  | -5.75  | -4.75 | -4.25 | -3.25 | 0.00  |      | 3.71 | 4.71 | 5.21  | 6.21  |       |       |       | 8.31 |       |
| PARZIALI PROGETTO    |      |        |        |        |      | 2.43   | 1.00   | 0.50  | 1.00  | 3.25  |       | 3.71 | 1.00 | 0.50 | 1.00  | 2.10  |       |       |       |      |       |
| QUOTE PROGETTO       |      |        |        |        |      | 7.38   | 9.81   | 10.16 | 10.07 | 10.03 | 9.88  |      | 9.72 | 9.68 | 9.76  | 9.41  |       |       |       | 7.31 |       |

PROFILO lavoriaFE2

SEZIONE 29

PROGRESSIVA 520.00

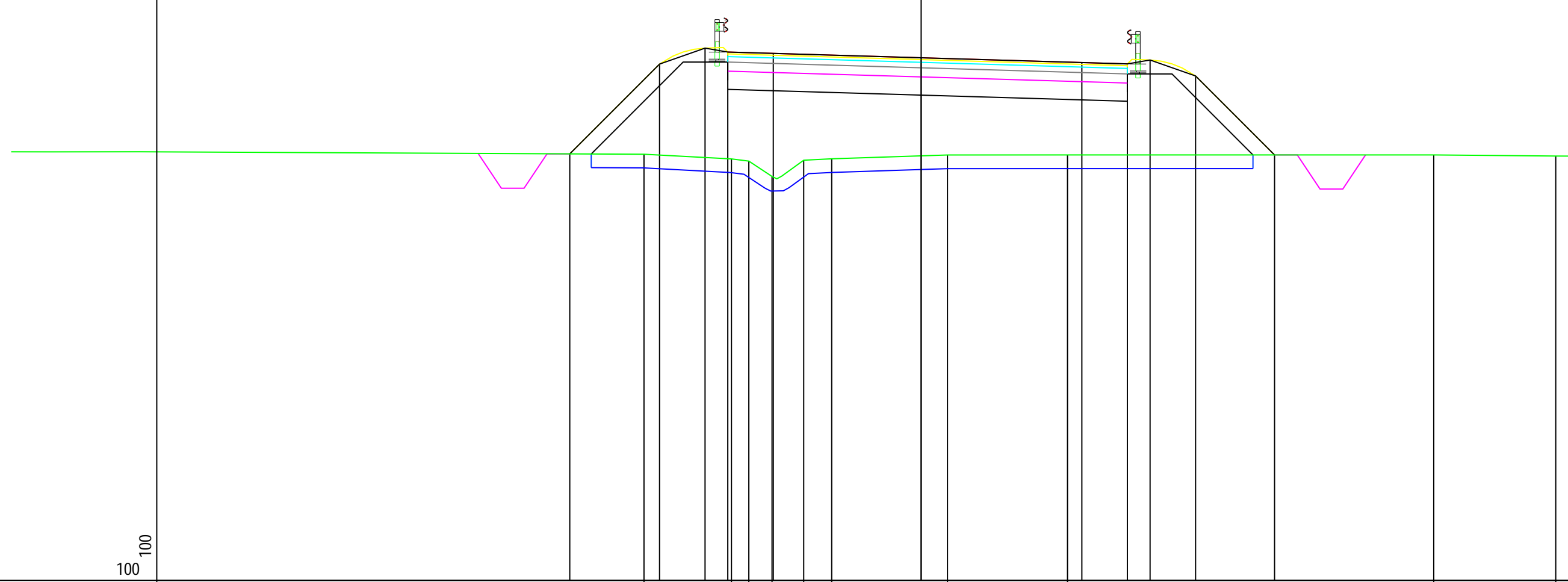

-2

100  
100

|                      |  |       |       |       |       |       |       |       |       |       |      |      |      |      |      |      |      |       |      |       |
|----------------------|--|-------|-------|-------|-------|-------|-------|-------|-------|-------|------|------|------|------|------|------|------|-------|------|-------|
| PROGRESSIVE TERRENO  |  |       |       | -6.09 |       | -4.17 | -3.79 | -3.28 | -2.58 | -1.97 |      | 0.58 |      | 3.22 |      |      |      | 11.27 |      | 13.95 |
| PARZIALI TERRENO     |  | 11.09 |       |       | 1.92  | 0.38  | 0.51  | 0.70  | 0.61  |       | 2.55 |      | 2.64 |      |      | 8.05 |      | 2.68  |      | 6.05  |
| QUOTE TERRENO        |  |       |       | 7.36  |       | 7.26  | 7.21  | 6.88  | 7.23  | 7.26  |      | 7.35 |      | 7.35 |      |      |      | 7.35  |      | 7.32  |
| PROGRESSIVE PROGETTO |  |       | -7.72 |       | -5.75 | -4.75 | -4.25 | -3.25 |       |       | 0.00 |      | 3.53 |      | 4.53 | 5.03 | 6.03 |       | 7.77 |       |
| PARZIALI PROGETTO    |  |       | 1.97  |       | 1.00  | 0.50  | 1.00  |       |       | 3.25  |      | 3.53 |      | 1.00 | 0.50 | 1.00 | 1.74 |       |      |       |
| QUOTE PROGETTO       |  |       | 7.37  |       | 9.35  | 9.70  | 9.61  | 9.58  |       |       | 9.48 |      | 9.38 |      | 9.35 | 9.43 | 9.08 |       | 7.35 |       |

PROFILO lavoriaFE2

SEZIONE 30

PROGRESSIVA 540.00

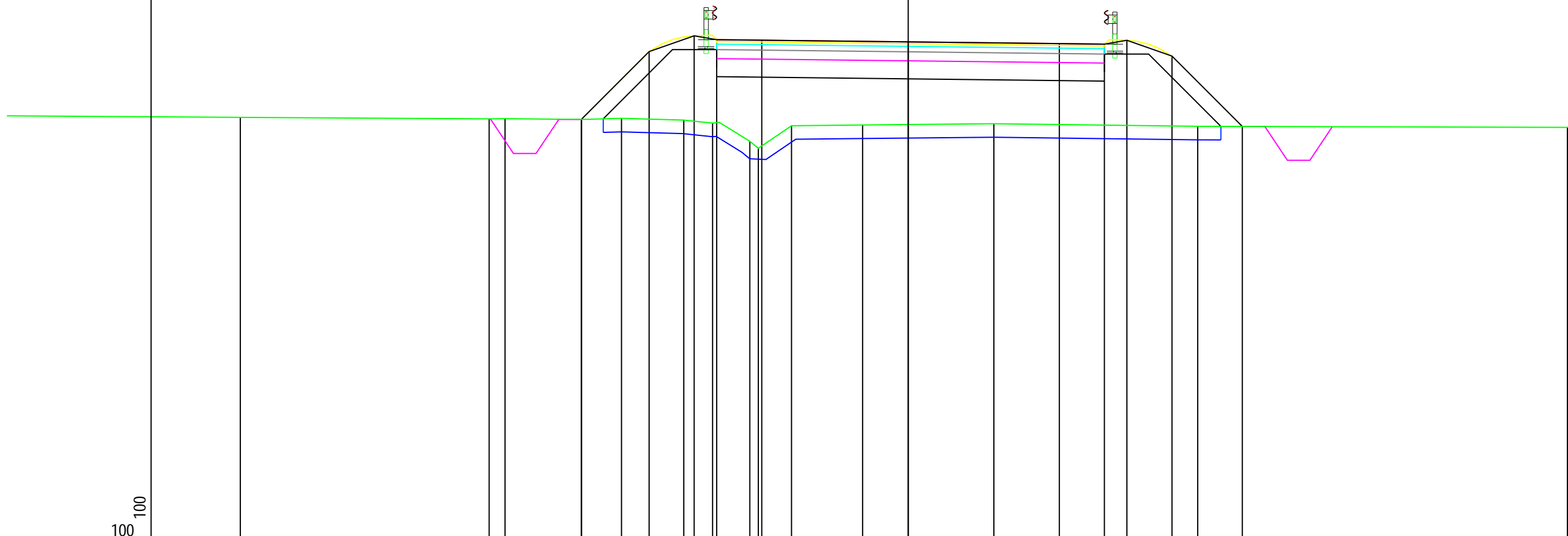

-2

100  
100

|                      |        |       |       |       |       |       |       |       |       |       |       |      |      |       |      |      |
|----------------------|--------|-------|-------|-------|-------|-------|-------|-------|-------|-------|-------|------|------|-------|------|------|
| PROGRESSIVE TERRENO  | -14.82 | -9.30 | -8.95 | -7.25 | -6.36 | -4.98 | -4.34 | -3.52 | -3.33 | -2.59 | -1.01 | 1.90 | 6.42 | 14.63 |      |      |
| PARZIALI TERRENO     | 5.18   | 0.35  | 1.70  | 0.89  | 1.38  | 0.64  | 0.82  | 0.19  | 0.74  | 1.58  | 2.91  | 4.52 | 8.21 | 2.73  |      |      |
| QUOTE TERRENO        | 7.41   | 7.38  | 7.38  | 7.36  | 7.39  | 7.35  | 7.28  | 6.88  | 6.72  | 7.22  | 7.24  | 7.27 | 7.21 | 7.19  |      |      |
| PROGRESSIVE PROGETTO |        |       |       | -7.25 | -5.75 | -4.75 | -4.25 | -3.25 |       | 0.00  |       | 3.35 | 4.35 | 4.85  | 5.85 | 7.41 |
| PARZIALI PROGETTO    |        |       |       | 1.50  | 1.00  | 0.50  | 1.00  |       | 3.25  |       | 3.35  | 1.00 | 0.50 | 1.00  | 1.56 |      |
| QUOTE PROGETTO       |        |       |       | 7.36  | 8.87  | 9.22  | 9.13  | 9.12  |       | 9.08  |       | 9.05 | 9.03 | 9.12  | 8.77 | 7.21 |

PROFILO lavoriaFE2

SEZIONE 31

PROGRESSIVA 560.00

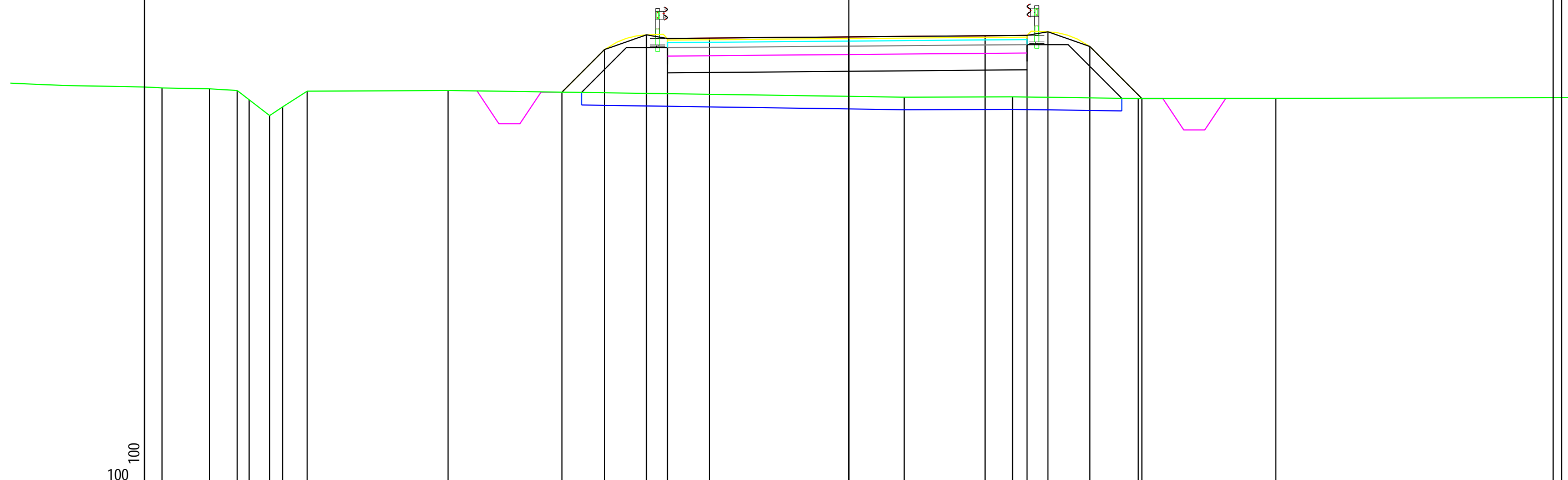

|                      |       |       |       |       |       |       |       |       |       |       |       |       |       |      |      |      |      |      |      |
|----------------------|-------|-------|-------|-------|-------|-------|-------|-------|-------|-------|-------|-------|-------|------|------|------|------|------|------|
| PROGRESSIVE TERRENO  | 16.80 | 16.38 | 15.25 | 14.59 | 14.30 | 13.81 | 13.51 | 12.92 | 9.56  | 1.32  | 3.91  | 6.90  | 10.19 |      |      |      |      |      |      |
| PARZIALI TERRENO     | 1.90  | 0.42  | 1.13  | 0.66  | 0.29  | 0.49  | 0.30  | 0.59  | 3.36  | 10.88 | 2.59  | 2.99  | 3.29  | 9.81 |      |      |      |      |      |
| QUOTE TERRENO        | 7.49  | 7.47  | 7.45  | 7.41  | 7.19  | 6.81  | 7.01  | 7.39  | 7.41  | 7.25  | 7.26  | 7.22  | 7.22  |      |      |      |      |      |      |
| PROGRESSIVE PROGETTO |       |       |       |       |       |       |       |       | -6.84 | -5.83 | -4.83 | -4.33 | -3.33 | 0.00 | 3.25 | 4.25 | 4.75 | 5.75 | 6.99 |
| PARZIALI PROGETTO    |       |       |       |       |       |       |       |       | 1.01  | 1.00  | 0.50  | 1.00  | 3.33  | 3.25 | 1.00 | 0.50 | 1.00 | 1.24 |      |
| QUOTE PROGETTO       |       |       |       |       |       |       |       |       | 7.37  | 8.38  | 8.73  | 8.65  | 8.66  | 8.68 | 8.71 | 8.72 | 8.81 | 8.45 | 7.22 |

PROFILO lavoriaFE2  
 SEZIONE 32  
 PROGRESSIVA 580.00

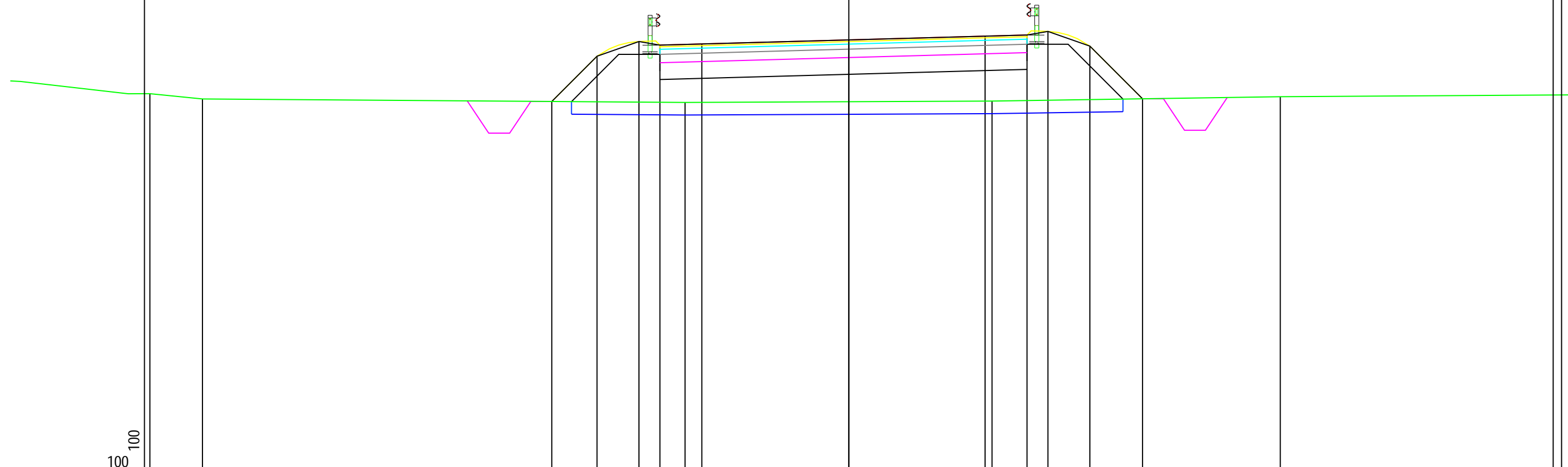

|                      |      |        |        |       |       |       |       |       |      |      |      |      |      |      |       |
|----------------------|------|--------|--------|-------|-------|-------|-------|-------|------|------|------|------|------|------|-------|
| PROGRESSIVE TERRENO  |      | -16.67 | -15.42 |       |       |       | -3.91 |       |      |      | 3.42 |      |      |      | 10.29 |
| PARZIALI TERRENO     | 0.52 | 1.25   |        | 11.51 |       |       |       | 7.33  |      |      | 6.87 |      |      | 9.71 |       |
| QUOTE TERRENO        | 7.02 | 6.90   |        |       |       |       | 6.82  |       |      |      | 6.85 |      |      | 6.95 |       |
| PROGRESSIVE PROGETTO |      |        |        | -7.08 | -6.01 | -5.01 | -4.51 | -3.51 | 0.00 |      | 3.25 | 4.25 | 4.75 | 5.75 | 7.01  |
| PARZIALI PROGETTO    |      |        |        | 1.07  | 1.00  | 0.50  | 1.00  | 3.51  |      | 3.25 | 1.00 | 0.50 | 1.00 | 1.26 |       |
| QUOTE PROGETTO       |      |        |        | 6.84  | 7.92  | 8.27  | 8.18  | 8.21  | 8.31 |      | 8.40 | 8.42 | 8.51 | 8.16 | 6.90  |



PROFILO lavoriaFE2

SEZIONE 33

PROGRESSIVA 600.00

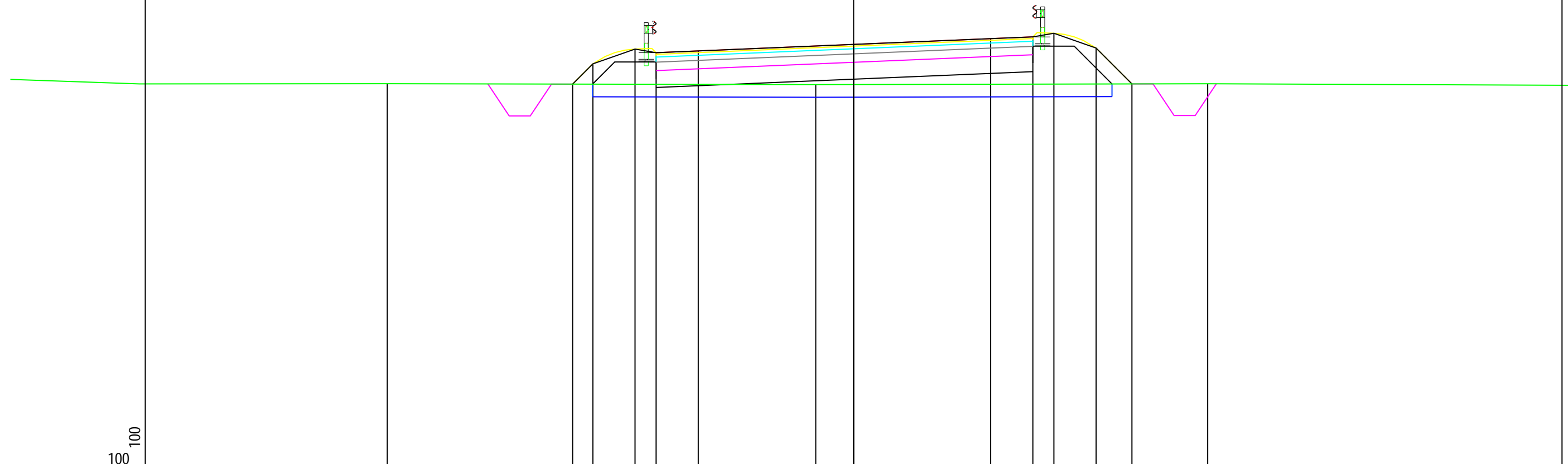

-2

100  
100

|                      |      |        |                |                |       |      |                      |              |
|----------------------|------|--------|----------------|----------------|-------|------|----------------------|--------------|
| PROGRESSIVE TERRENO  |      | -11.06 |                | -0.90          |       | 8.40 |                      |              |
| PARZIALI TERRENO     | 5.88 |        | 10.16          |                | 9.30  |      | 9.94                 |              |
| QUOTE TERRENO        |      | 7.14   |                | 7.12           |       | 7.14 |                      |              |
| PROGRESSIVE PROGETTO |      |        | -6.66<br>-6.18 | -5.18<br>-4.69 | -3.69 | 0.00 | 3.25<br>4.25<br>4.75 | 5.75<br>6.60 |
| PARZIALI PROGETTO    |      |        | 0.48<br>1.00   | 0.49<br>1.00   | 3.69  |      | 1.00<br>0.50<br>1.00 | 0.85         |
| QUOTE PROGETTO       |      |        | 7.13<br>7.61   | 7.96<br>7.88   | 7.92  | 8.07 | 8.21<br>8.25<br>8.34 | 7.99<br>7.14 |

PROFILO lavoriaFE2  
 SEZIONE 34  
 PROGRESSIVA 620.00

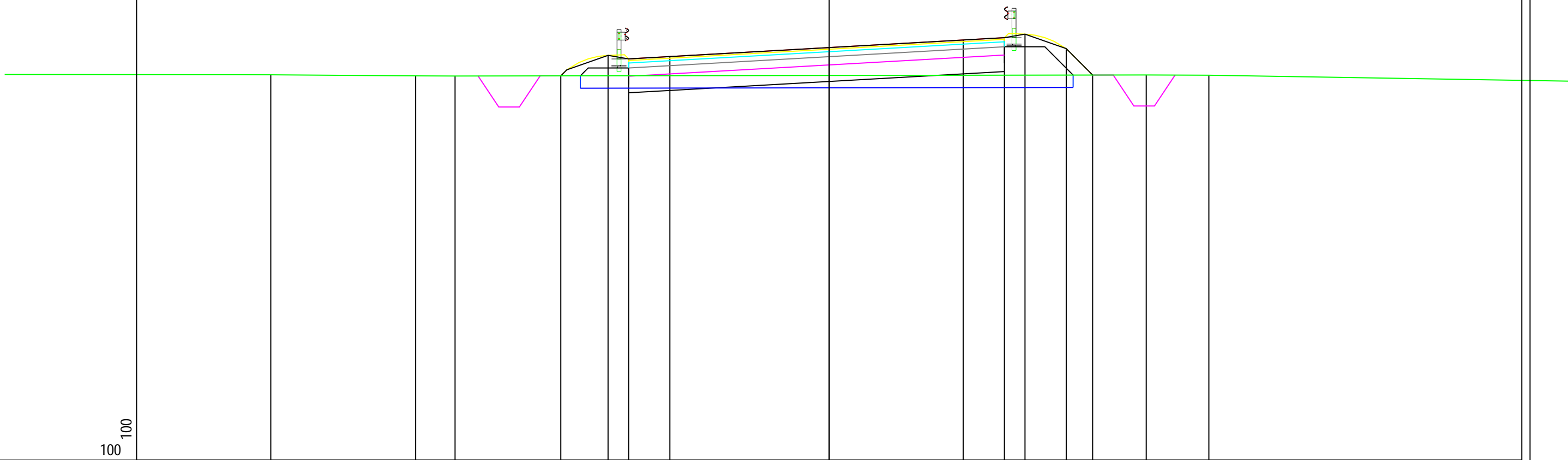

-2

100  
100

|                      |      |        |        |       |       |       |       |       |      |      |      |      |       |      |      |      |
|----------------------|------|--------|--------|-------|-------|-------|-------|-------|------|------|------|------|-------|------|------|------|
| PROGRESSIVE TERRENO  |      | -13.55 | -10.03 | -9.08 |       |       |       |       |      |      | 7.69 | 9.21 |       |      |      |      |
| PARZIALI TERRENO     | 6.45 |        | 3.52   | 0.95  |       | 16.77 |       |       |      |      | 1.52 |      | 10.79 |      |      |      |
| QUOTE TERRENO        |      | 7.34   |        | 7.31  | 7.31  |       |       |       |      |      | 7.34 | 7.33 |       |      |      |      |
| PROGRESSIVE PROGETTO |      |        |        |       | -6.51 | -5.36 | -4.86 | -3.86 |      | 0.00 |      | 3.25 | 4.25  | 4.75 | 5.75 | 6.39 |
| PARZIALI PROGETTO    |      |        |        |       | 1.15  | 0.50  | 1.00  |       | 3.86 |      | 3.25 | 1.00 | 0.50  | 1.00 | 0.64 |      |
| QUOTE PROGETTO       |      |        |        |       | 7.31  | 7.81  | 7.73  | 7.78  |      | 8.00 |      | 8.18 | 8.24  | 8.33 | 7.97 | 7.33 |

PROFILO lavoriaFE2

SEZIONE 35

PROGRESSIVA 640.00

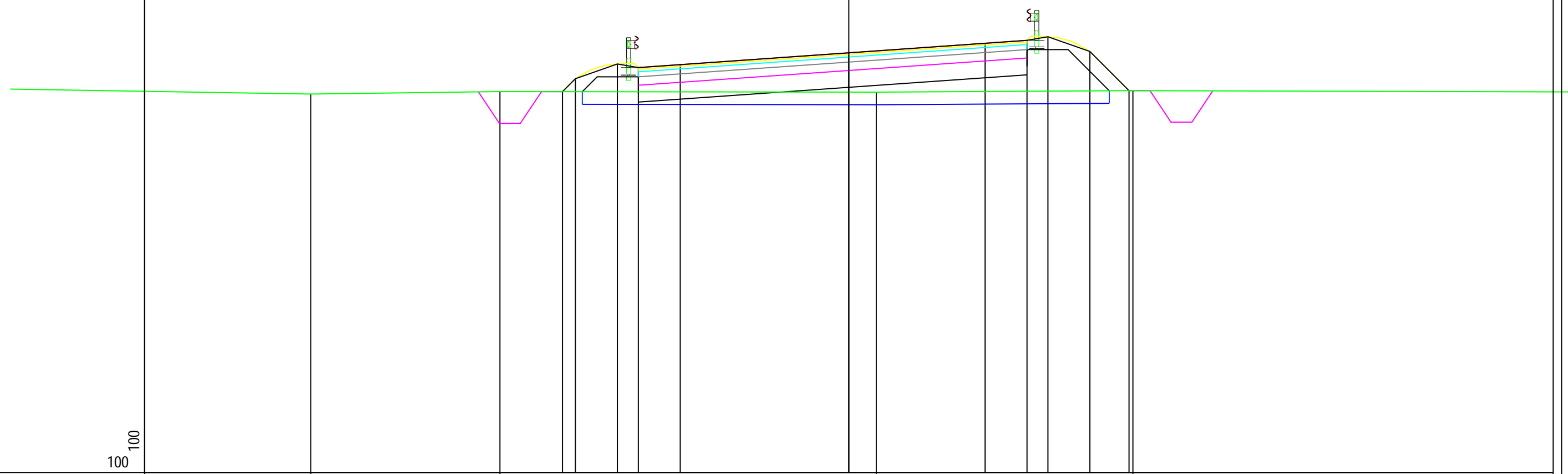

|                      |      |        |      |       |  |       |       |       |       |       |      |      |       |      |      |      |      |      |
|----------------------|------|--------|------|-------|--|-------|-------|-------|-------|-------|------|------|-------|------|------|------|------|------|
| PROGRESSIVE TERRENO  |      | -12.83 |      | -8.32 |  |       |       | 0.66  |       |       |      | 6.78 |       |      |      |      |      |      |
| PARZIALI TERRENO     | 7.17 |        | 4.51 |       |  |       | 8.98  |       |       |       | 6.12 |      | 10.25 |      |      |      |      |      |
| QUOTE TERRENO        |      | 7.02   |      | 7.08  |  |       |       | 7.06  |       |       |      | 7.10 |       |      |      |      |      |      |
| PROGRESSIVE PROGETTO |      |        |      |       |  | -6.83 | -6.52 | -5.52 | -5.02 | -4.02 |      | 0.00 |       | 3.25 | 4.25 | 4.75 | 5.75 | 6.68 |
| PARZIALI PROGETTO    |      |        |      |       |  | 0.31  | 1.00  | 0.50  | 1.00  |       | 4.02 |      | 3.25  |      | 1.00 | 0.50 | 1.00 | 0.93 |
| QUOTE PROGETTO       |      |        |      |       |  | 7.07  | 7.38  | 7.73  | 7.65  | 7.72  |      | 8.00 |       | 8.23 | 8.30 | 8.38 | 8.03 | 7.10 |

PROFILO lavoriaFE2

SEZIONE 36

PROGRESSIVA 660.00

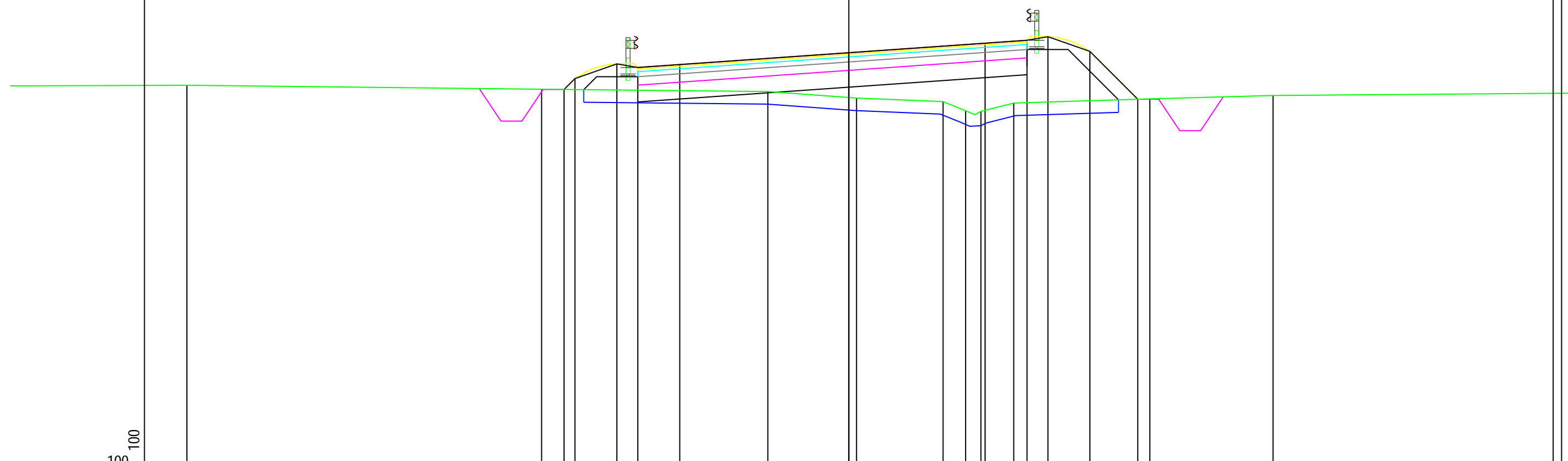

-2

100  
100

|                      |        |       |       |       |      |      |      |      |      |       |      |      |
|----------------------|--------|-------|-------|-------|------|------|------|------|------|-------|------|------|
| PROGRESSIVE TERRENO  | -15.79 | -7.33 | -1.93 | 0.18  | 2.25 | 2.79 | 3.15 | 3.93 | 7.18 | 10.12 |      |      |
| PARZIALI TERRENO     | 4.21   | 8.46  | 5.40  | 2.11  | 2.07 | 0.54 | 0.36 | 0.78 | 3.25 | 2.94  | 7.07 |      |
| QUOTE TERRENO        | 7.22   | 7.13  | 7.07  | 6.92  | 6.83 | 6.62 | 6.60 | 6.80 | 6.90 | 6.98  |      |      |
| PROGRESSIVE PROGETTO |        | -6.79 | -5.53 | -4.03 | 0.00 | 3.25 | 4.25 | 4.75 | 5.75 | 6.89  |      |      |
| PARZIALI PROGETTO    |        | 0.26  | 1.00  | 0.50  | 1.00 | 4.03 | 3.25 | 1.00 | 0.50 | 1.00  | 1.14 |      |
| QUOTE PROGETTO       |        | 7.12  | 7.38  | 7.73  | 7.65 | 7.72 | 8.00 | 8.23 | 8.30 | 8.38  | 8.03 | 6.89 |

PROFILO lavoriaFE2

SEZIONE 37

PROGRESSIVA 680.00

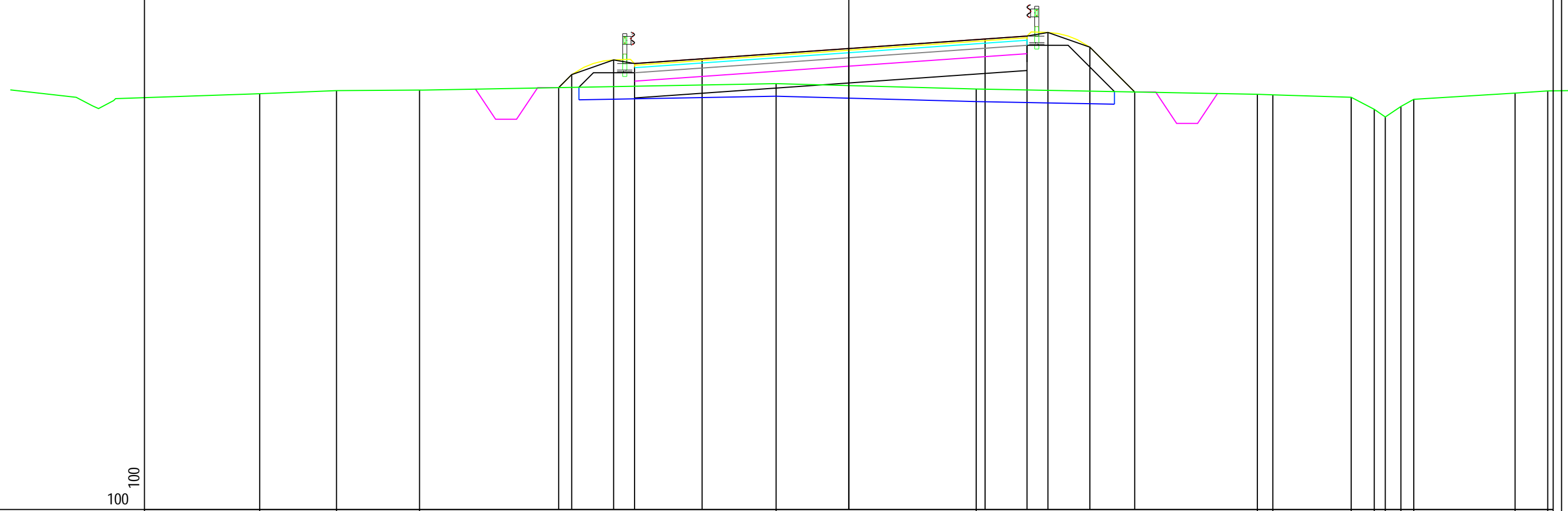

-3

100  
100

|                      |      |        |        |        |       |       |       |       |       |      |       |       |       |       |       |       |       |       |      |
|----------------------|------|--------|--------|--------|-------|-------|-------|-------|-------|------|-------|-------|-------|-------|-------|-------|-------|-------|------|
| PROGRESSIVE TERRENO  |      | -14.05 | -12.22 | -10.24 |       | -1.73 |       | 3.04  |       | 9.74 | 10.11 | 11.98 | 12.53 | 12.80 | 13.17 | 13.48 | 15.89 | 16.67 |      |
| PARZIALI TERRENO     | 3.48 | 1.83   | 1.98   |        | 8.51  |       | 4.77  |       | 6.70  | 0.37 | 1.87  | 0.55  | 0.27  | 0.37  | 0.31  |       | 2.41  | 0.78  | 0.92 |
| QUOTE TERRENO        |      | 6.92   | 7.00   | 7.01   |       | 7.16  |       | 7.03  |       | 6.91 | 6.89  | 6.84  | 6.55  | 6.37  | 6.62  | 6.79  |       | 6.94  | 6.99 |
| PROGRESSIVE PROGETTO |      |        |        |        | -6.92 | -6.61 | -5.61 | -5.11 | -3.50 | 0.00 | 3.25  | 4.25  | 4.75  | 5.75  | 6.82  |       |       |       |      |
| PARZIALI PROGETTO    |      |        |        |        | 0.31  | 1.00  | 0.50  | 1.61  |       | 3.50 |       | 3.25  | 1.00  | 0.50  | 1.00  | 1.07  |       |       |      |
| QUOTE PROGETTO       |      |        |        |        | 7.07  | 7.38  | 7.73  | 7.64  | 7.76  | 8.00 |       | 8.23  | 8.30  | 8.38  | 8.03  | 6.96  |       |       |      |

PROFILO lavoriaFE2

SEZIONE 38

PROGRESSIVA 700.00

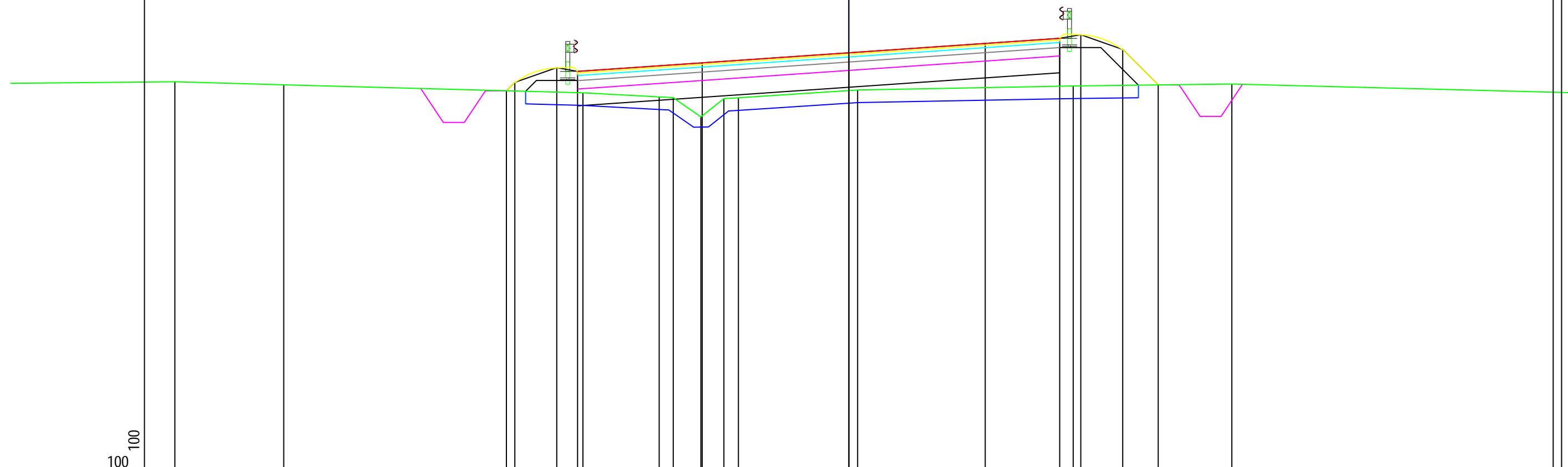

-2

100 100

|                      |        |        |       |       |       |       |       |       |      |      |      |      |      |
|----------------------|--------|--------|-------|-------|-------|-------|-------|-------|------|------|------|------|------|
| PROGRESSIVE TERRENO  | -16.07 | -13.48 | -6.34 | -4.52 | -4.19 | -3.53 | -2.98 | -2.63 | 0.21 | 5.35 | 9.13 |      |      |
| PARZIALI TERRENO     | 3.93   | 2.59   | 7.14  | 1.82  | 0.33  | 0.66  | 0.55  | 0.35  | 2.84 | 5.14 | 3.78 | 9.06 |      |
| QUOTE TERRENO        | 7.31   | 7.24   | 7.05  | 6.95  | 6.93  | 6.47  | 6.91  | 6.93  | 7.11 | 7.21 | 7.26 |      |      |
| PROGRESSIVE PROGETTO |        |        | -8.17 | -7.97 | -6.97 | -6.47 | -3.50 | 0.00  | 3.25 | 5.03 | 5.53 | 6.53 | 7.38 |
| PARZIALI PROGETTO    |        |        | 0.20  | 1.00  | 0.50  | 2.97  | 3.50  | 3.25  | 1.78 | 0.50 | 1.00 | 0.85 |      |
| QUOTE PROGETTO       |        |        | 7.09  | 7.30  | 7.65  | 7.56  | 7.76  | 8.00  | 8.22 | 8.34 | 8.43 | 8.08 | 7.23 |

