

Scala 1:400 - Verifica iscrizione mezzi pesanti

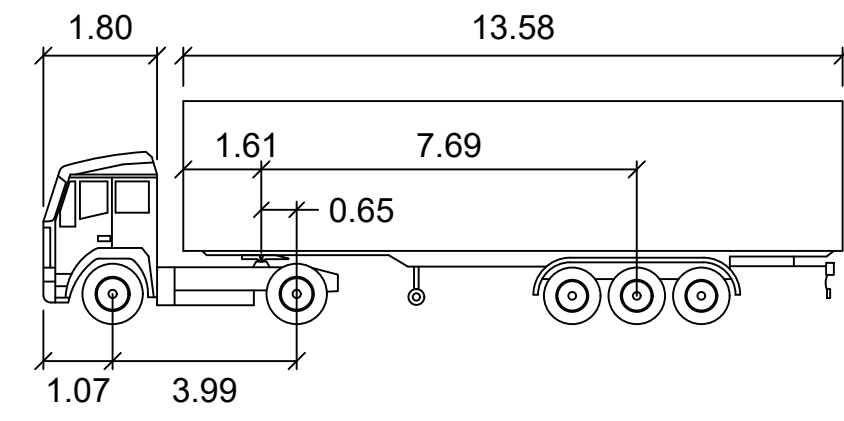

CAMION SEMI ARTICOLATO

Amplezza motrice	: 2.48	Tempo da blocco a blocco	: 6.0
Amplezza rimorchio	: 2.55	Angolo di sterzata	: 38.5
Carreggiata motrice	: 2.41	Angolo di snodo	: 70.0
Carreggiata rimorchio	: 2.43		

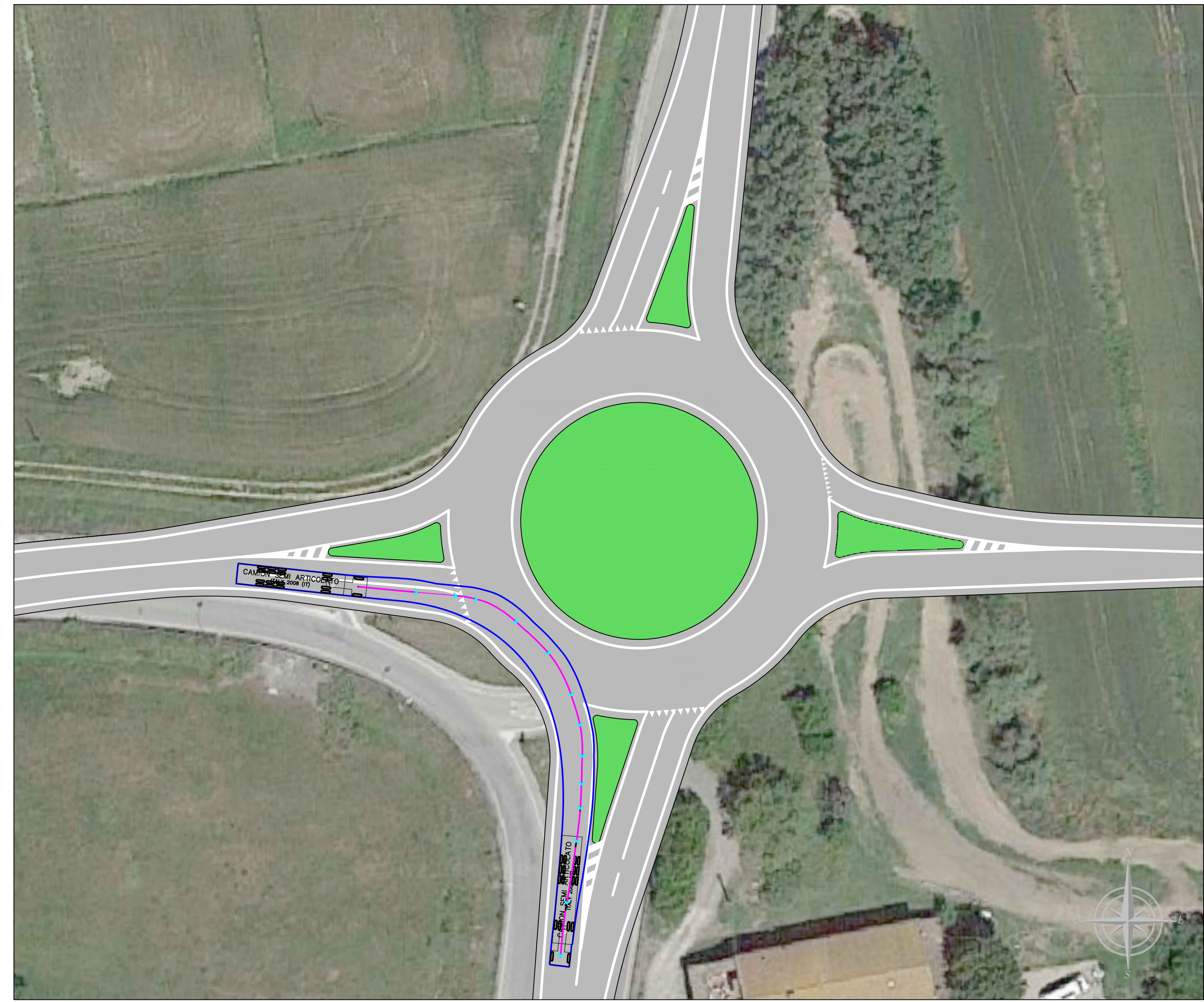
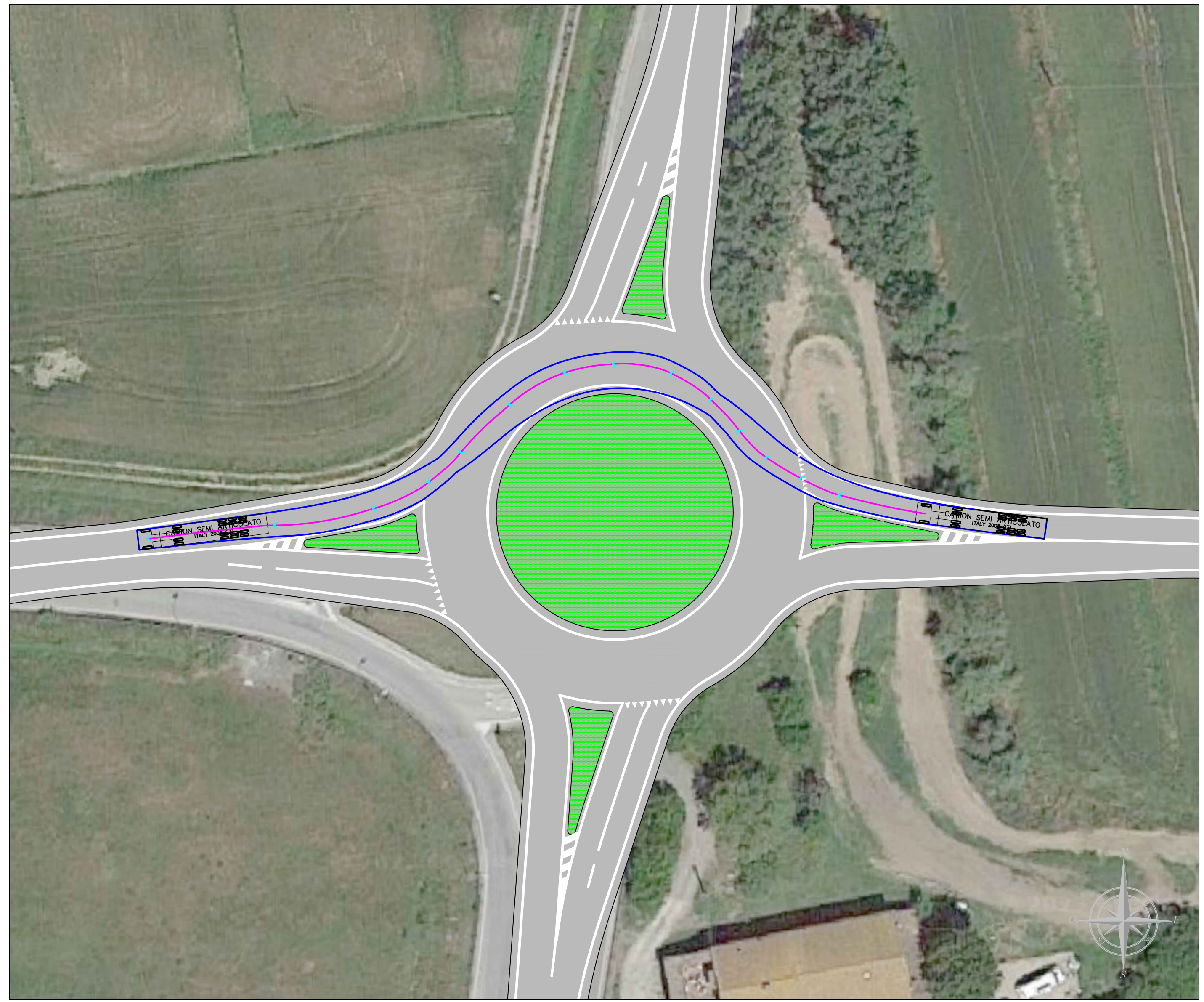
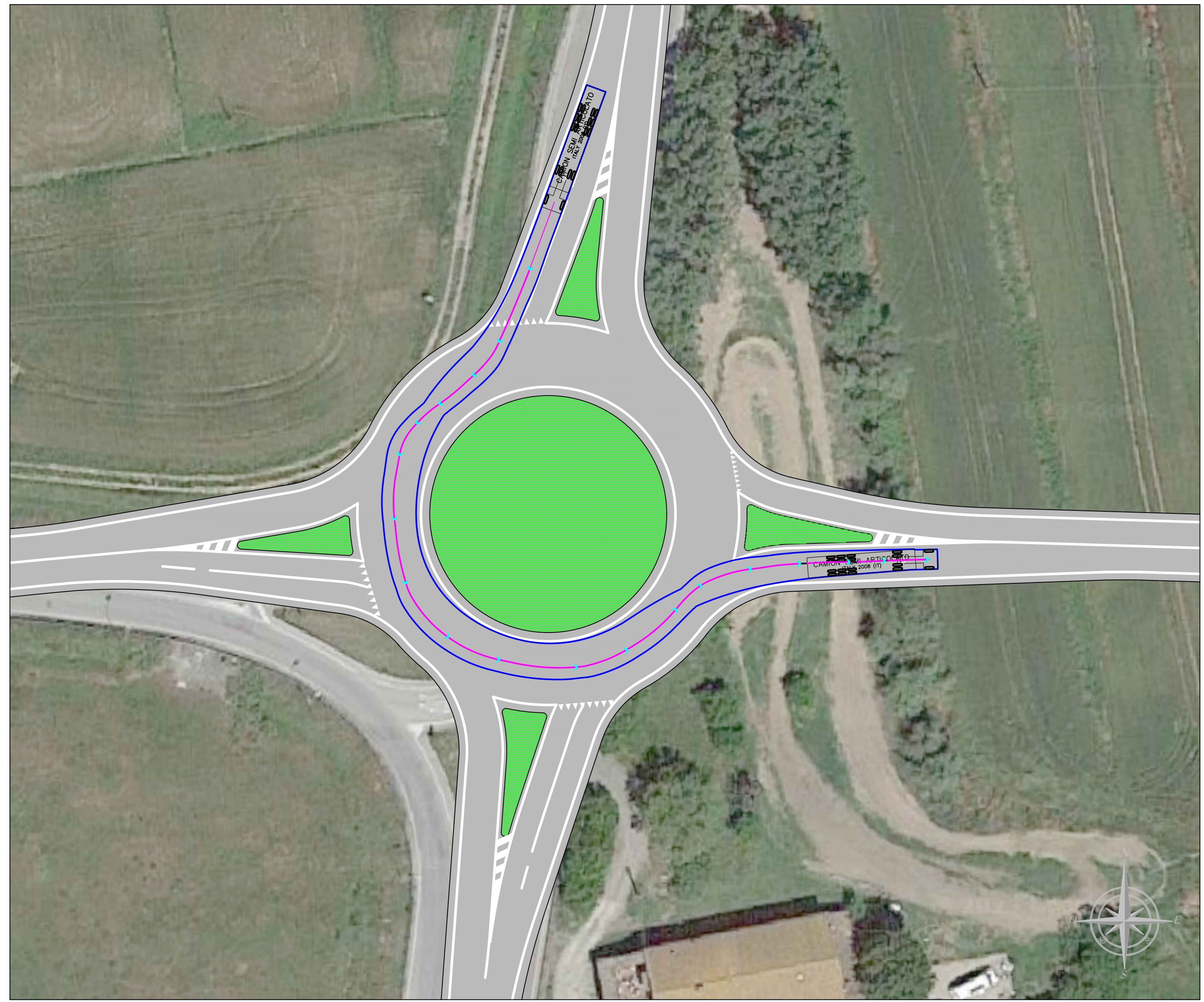

Scala 1:400 - Verifica visibilità

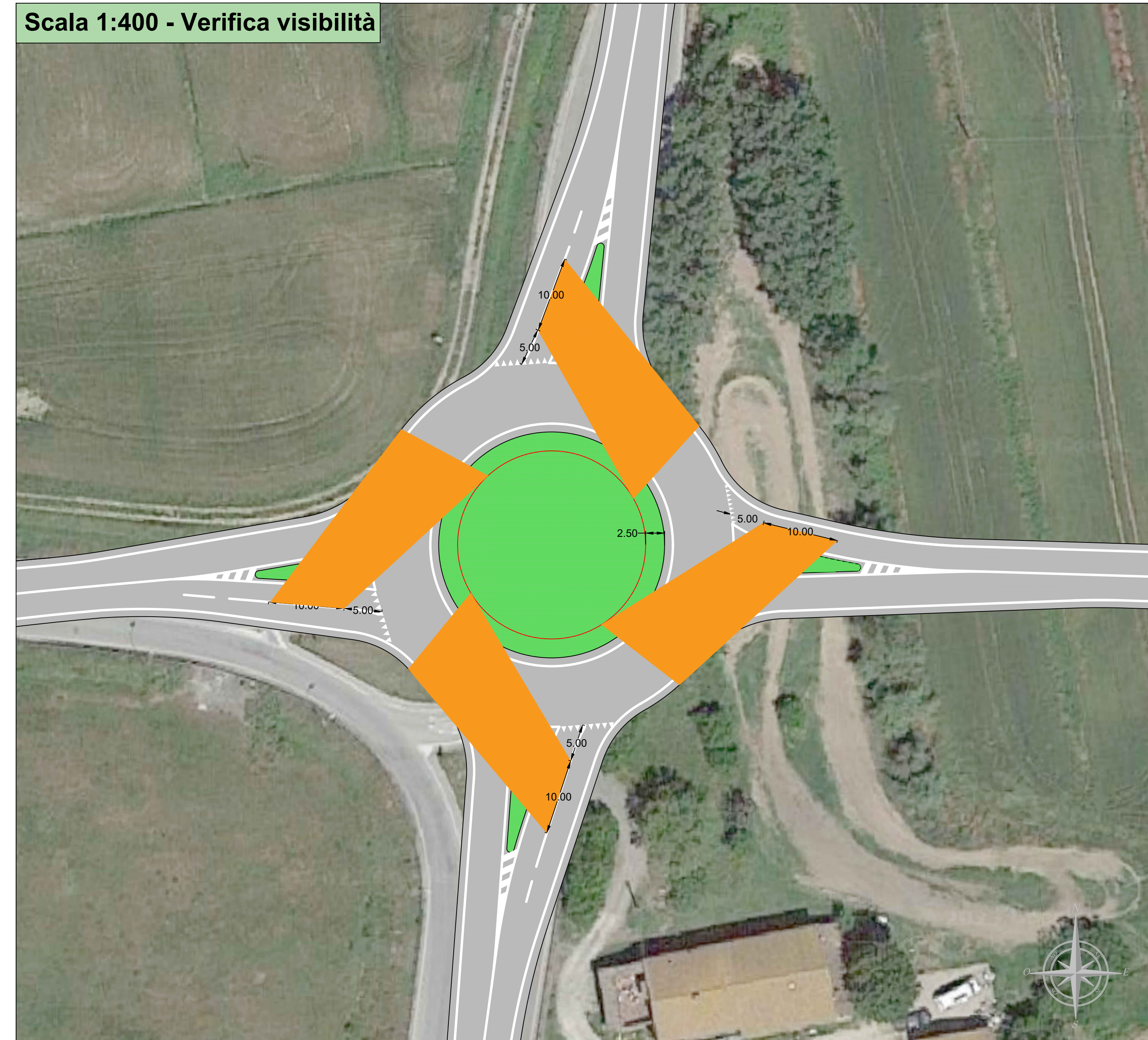

Scala 1:400 - Verifica angolo deflessione



Scala 1:400 - Verifica traiettorie deflessione

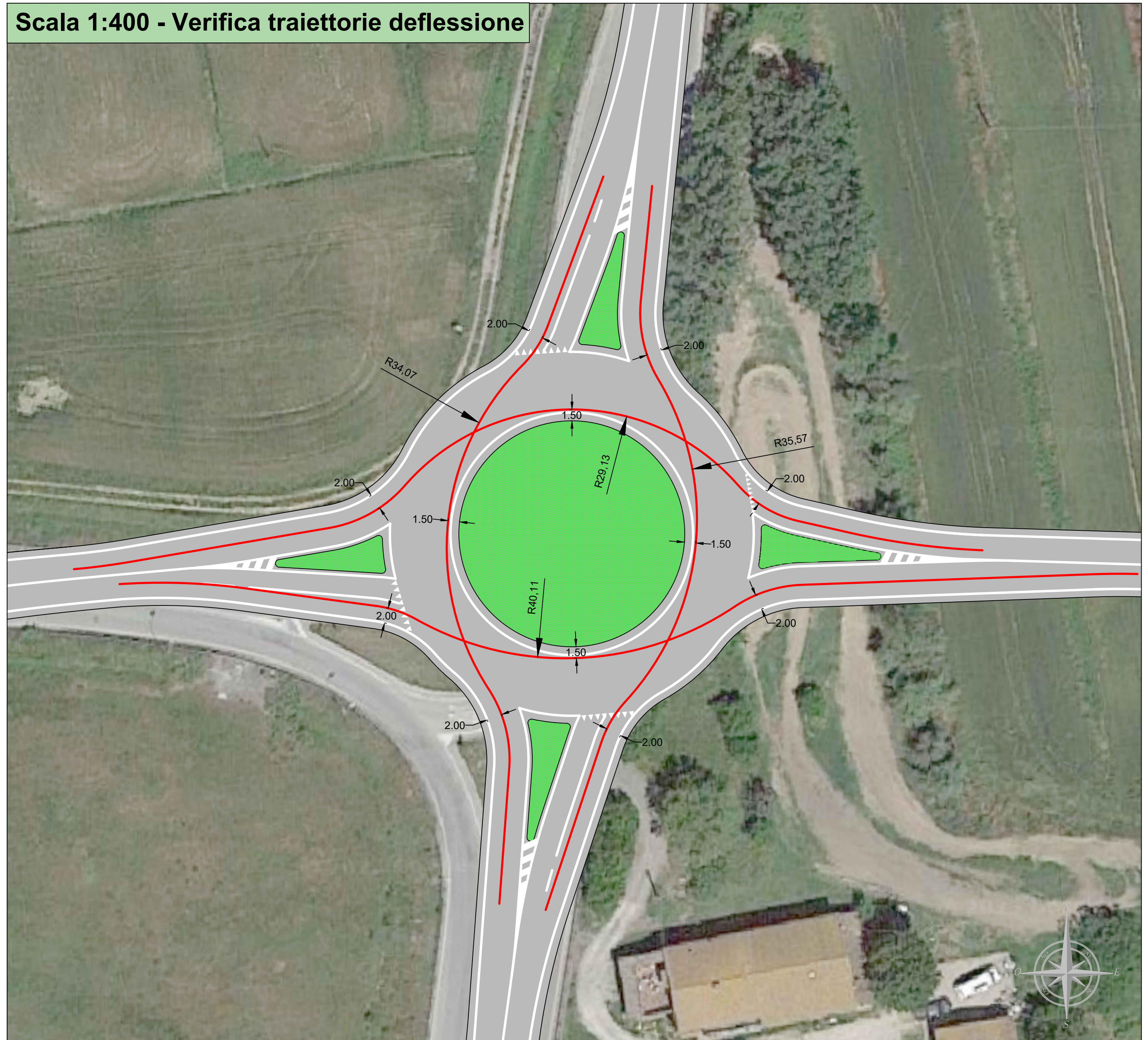

KEY MAP

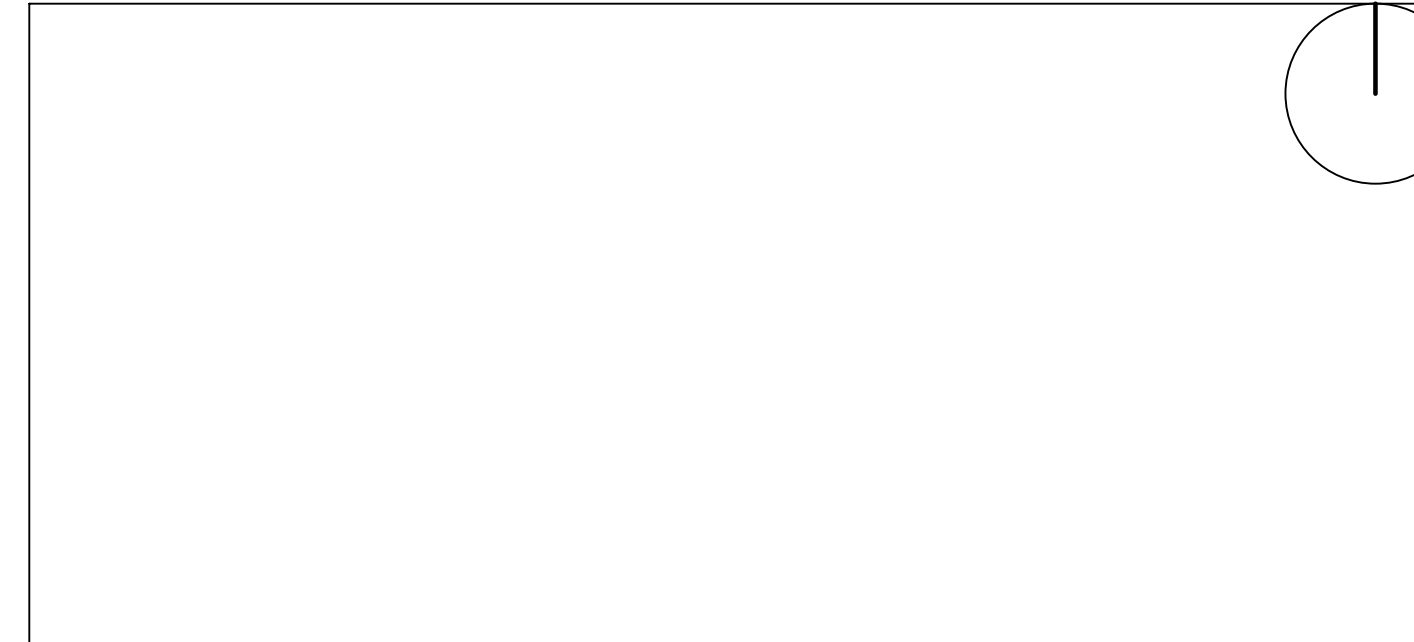

Techbau S.p.A.  
Via...  
00144 Roma (RM)  
Tel. +39 06 49811111  
www.techbau.it

**Techbau**  
Engineering & Construction

NO	2024/03/20	Descrizione	NC	NC
REVISOR	DATA	SITUS	DESCRIZIONE	DESCRIPTION
PROGETTISTA	PROGETTO	PROGETTO	PROGETTO	PROGETTO

CITTADELLA DELLA LOGISTICA - CRISPINA LORENZANA (PI)

TITOLO DOCUMENTO / Document Title: VERIFICHE ROTATORIA S.P.31

COMMESSA / Level: 23P08 D AR 030 GA - 00

SCALE / Scale: 1 : 400

PRODOTTORE / Produced by: Techbau S.p.A.

M030201